

*bcn*<sup>≡</sup>  
BENEDETTI LIGHTING



Lite & Bright

1959



2026

## legenda per articoli a LED legend for LED items

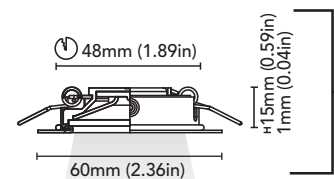

Caratteristiche generali dell'apparecchio (Vedi simboli grafici nella tabella sottostante)  
Fixture general features (See graphic symbols in the table below)

Dimensioni apparecchio  
Fixture sizes

**3412-60A-B1.5W**

Codice commerciale articolo  
Commercial item code

### SIMBOLI E SEGNI GRAFICI - SYMBOLS AND GRAPHIC SIGNS

	Classe I Class I		Classe II Class II		Classe III Class III		Apparecchio dimmerabile. Dimmable light fixture.		Apparecchio predisposto per il montaggio su superfici normalmente infiammabili. Light fitting for application on normally combustible surfaces.
--	---------------------	--	-----------------------	--	-------------------------	--	---	--	--

### GRADO DI PROTEZIONE IP- INGRESS PROTECTION RATE

<b>IP 20</b>	IP2- Protezione contro corpi solidi di dimensioni maggiori di 12mm. IP-0 Nessuna protezione contro l'acqua. IP2-Protection against solid objects larger than 12 mm. IP-0 No protection against water.
<b>IP 40</b>	IP4-Protezione contro oggetti solidi di dimensioni maggiori di 1mm. IP-0 Nessuna protezione contro l'acqua. IP4-Protection against solid objects larger than 1 mm. IP-0 No protection against water.
<b>IP 65</b>	IP6- Stagno alla polvere. IP-5 Protezione contro getti d'acqua. IP6- Full protection against dust. IP-5 Protection against jets of water.
<b>IP 66</b>	IP6- Stagno alla polvere. IP-6 Protezione contro forti getti d'acqua. IP6- Full protection against dust. IP-6 Protection against powerful jets of water.
<b>IP 67</b>	IP6- Stagno alla polvere. IP-7 Protezione contro l'immersione temporanea (<30min) fino a 1 metro di profondità. IP6- Full protection against dust. IP-7 Protection against temporary immersion (<30min) up to 1m in depth.
<b>IP 68</b>	IP6- Stagno alla polvere. IP-8 Protezione contro l'immersione prolungata (>30min) alla profondità di ... metri. IP6- Full protection against dust. IP-8 Protection against continuous immersion in water (>30min) at a depth of ... meters.

### INDICE DI PROTEZIONE DAGLI IMPATTI IK - IMPACT PROTECTION RATE IK

<b>IK 9</b>	Protezione contro un impatto da 10 Joule, equivalente alla caduta di un oggetto di 5kg da 20 centimetri di altezza. Protection against a 10 joules impact, equivalent to impact of 5 kg mass dropped from a height of 20 cm.	 Walkable
<b>IK 10</b>	Protezione contro un impatto da 20 Joule, equivalente alla caduta di un oggetto di 5kg da 40 centimetri di altezza. Protection against a 20 joules impact, equivalent to impact of 5 kg mass dropped from a height of 40 cm.	

Tutti gli apparecchi di illuminazione presenti in questo catalogo sono costruiti in conformità alle Normative Europee EN 60598-1 e 60598-2... ed equivalenti alle Norme Internazionali IEC 60598-1 e 60598-2...L'azienda garantisce che i prodotti sono conformi ai requisiti essenziali delle seguenti Direttive Europee UE-CE:  
**DBT 2014/35/UE** (Direttiva Bassa Tensione);  
**EMC 2014/30/UE** (Compatibilità Elettromagnetica);  
**RoHS 2002/95/CE** (Restrizioni sull'uso di sostanze pericolose);  
**RAEE 96/02/CE** (L'azienda salvaguarda l'ambiente aderendo ad un Consorzio);  
**ErP 2009/125/CE** (Etichetta Energetica).

Dichiarazione etica: per la ns. produzione non utilizziamo bambini e contribuiamo alla salvaguardia dell'ambiente. Dichiarazione di Origine del prodotto: in conformità al Regolamento 1207/01/CE (mod. Reg. 1617/2006, Reg. 75/2008).

Every lighting fixture contained in this catalogue is produced inside the firm, in compliance with the European Standard EN 60598-1 and 60598-2... and equivalent to the International Standard IEC 60598-1 and 60598-2...The company declares that products comply with the essential requirements of the following European Directives CE:  
**LVD 2014/35/EU** (Low Voltage Directive);  
**EMC 2014/30/EU** (Electromagnetic Compatibility);  
**RoHS 2002/95/CE** (Restrictions on the use of Hazardous Substances);  
**RAEE 96/02/CE** (The company protects the environment supporting a Pool);  
**ErP 2009/125/EU** (Energy Label).

Ethics statement: for our production we don't use children and contribute to the protection of the environment. Declaration of Origin of the product: according to Regulation 1207/01/CE (mod. Reg. 1617/2006, Reg. 75/2008).



**23**  
nero  
black



**20**  
bianco  
white



**4**  
acciaio lucido  
polished stainless steel



**34**  
acciaio satinato  
satin steel



**3**  
cromo lucido  
polished chrome

I colori per loro natura sono indicativi, ed eventuali leggere differenze sono da considerarsi nelle tolleranze. La spazzolatura delle finiture dona raffinatezza ai metalli ed è una particolarità che potrebbe variare secondo la tipologia dell'oggetto.  
 Colours are indicative for their own nature and any slight difference is to be considered within tolerance. Refined brushed finishes may vary according to the kind of item.

Downlights - 14

						
<b>vegas 1 16</b>	<b>vegas 2 18</b>	<b>memphis 1 20</b>	<b>ocean 22</b>	<b>ring 24</b>	<b>malibù 24 - 29</b>	<b>newport 30 - 33</b>

						
<b>orlando 34</b>	<b>phoenix 36</b>	<b>seattle 38 - 41</b>	<b>atlanta 42 - 45</b>	<b>charlotte 46</b>	<b>daytona 48</b>	<b>venice 50 - 53</b>

			
<b>miami 54</b>	<b>colorado 56</b>	<b>aspen 58</b>	<b>alabama 60</b>

Courtesy Lights - 62

						
<b>dallas 64 - 66</b>	<b>bedford 68</b>	<b>savannah 70</b>	<b>tampa 72</b>	<b>sarasota 72</b>	<b>florida 74</b>	<b>portland 76</b>

Our collections

Courtesy Lights - 62



					
<b>columbia 78</b>	<b>nevada 78</b>	<b>dana 80</b>	<b>baltimore 80</b>	<b>detroit 82</b>	<b>boston 82</b>

Reading Lights - 84

			
<b>catalina 86</b>	<b>ventura 88 - 91</b>	<b>arizona 92 - 95</b>	<b>philly 96 - 99</b>







Neonflex - 100

					
<b>ik 0606 102</b>	<b>ik 1010 104</b>	<b>ik 1617 106</b>	<b>duneflex 108</b>	<b>round smooth 112</b>	<b>round knit 114</b>

			
<b>neonflex 1010 116</b>	<b>neonflex 0606 side 118</b>	<b>neonflex 0606 top 118</b>	<b>profiles and accessories neonflex 120 - 123</b>

Our collections

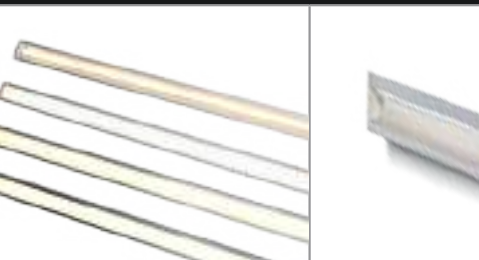
Linear Lighting Systems - 124

					
mini blade one, two, three 126	blade one 128	blade two 130	blade three 132	blade four 134	blade five 136

	
miniflex 138	flex 140

Anti-glare - 142

					
malibù ag 144	newport ag 146	orlando ag 148	phoenix ag 150	seattle ag 152	atlanta ag 154

					
charlotte ag 156	daytona ag 158	alabama ag 160	tampa ag 162	sarasota ag 162	black 164

Our collections

Anti-glare - 142

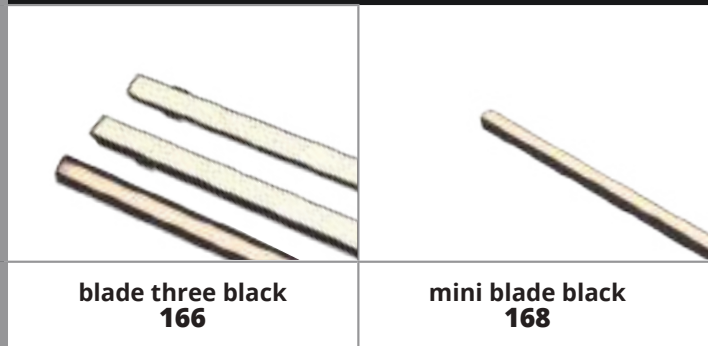

Track system - 170

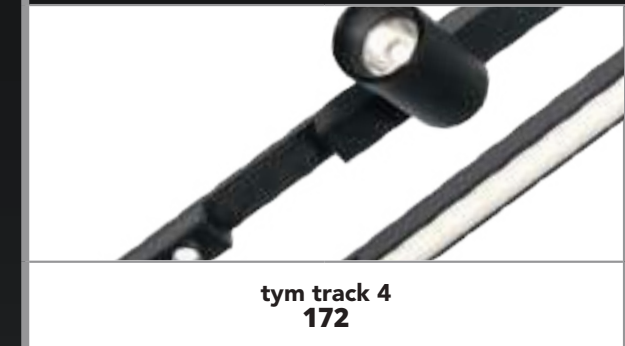



CAPITOLO - CHAPTER

PAGINA - PAGE

	<b>Downlights</b>	<b>14</b>
	<b>Courtesy Lights</b>	<b>62</b>
	<b>Reading Lights</b>	<b>84</b>
	<b>Neonflex</b>	<b>100</b>

CAPITOLO - CHAPTER

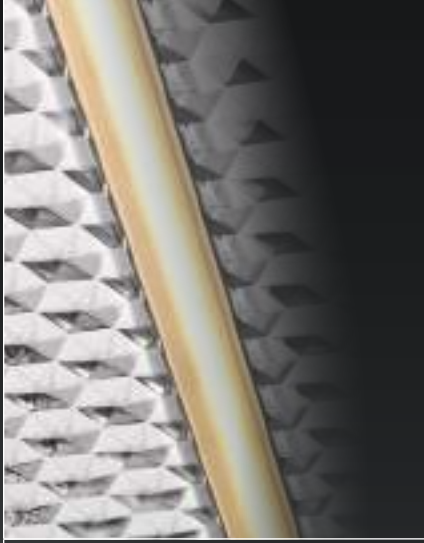
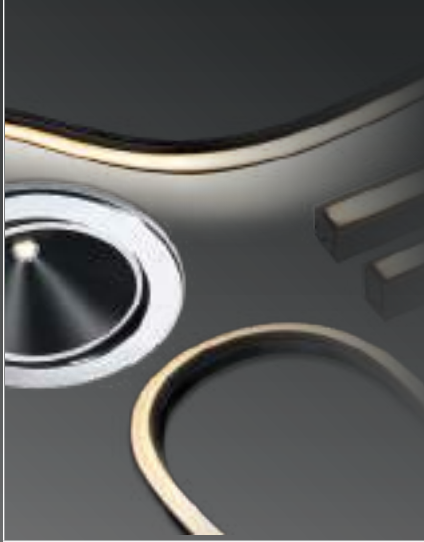
PAGINA - PAGE

	<b>Linear Lighting Systems</b>	<b>124</b>
	<b>Anti-glare</b>	<b>142</b>
	<b>Track system</b>	<b>170</b>



# Downlights

Questa linea di faretti si distingue per l'eccellenza dei materiali impiegati e l'alta efficienza luminosa. Tutti gli articoli, orientabili compresi, hanno grado di protezione IP66. L'elegante design si integra perfettamente negli ambienti esterni ed interni. Il corpo stampato in special compound rende i prodotti estremamente versatili, ultraleggeri e compatibili con diversi tipi di superficie.

*The downlights of this collection stand up for the excellence of the materials and the high efficiency of the light output. All the articles, adjustable included, are IP66 protection rate. The elegant design is perfectly suitable with both interior and exterior environments. The back-body, made of a special compound, make all the downlights ultra-light and compatible with different types of surfaces.*



# vegas 1

. 50

. 65

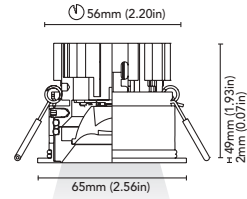
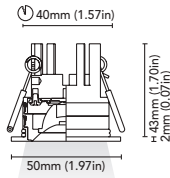

CODE	<b>3552-50-P4.5W</b>
FIXTURE	FIXED DOWNLIGHT
ADJUSTABILITY	NO
LIGHT SOURCE	POWER LED
POWER	MAX 4,5W
SUPPLY	16-32Vdc - wired driver
PROTECTION	FUSE - POLARITY REVERSE SPIKE FILTER
DIMMABLE	YES
BEAM	MEDIUM
SCREEN	LENS
LED COLOUR	3000K CRI >90 LMN 414lm 1mt 1828lx 2mt 457lx 3mt 203 lx
IP RATE	IP65
MATERIALS	BODY: ALUMINIUM HEATSINK: ALUMINUM
MOUNTING SYSTEM	WIRE SPRINGS
OPTIONAL LED COLOUR	2700K - 4000K

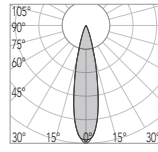

CODE	<b>3552-65-P6W</b>
FIXTURE	FIXED DOWNLIGHT
ADJUSTABILITY	NO
LIGHT SOURCE	POWER LED
POWER	MAX 6W
SUPPLY	16-32Vdc - wired driver
PROTECTION	FUSE - POLARITY REVERSE SPIKE FILTER
DIMMABLE	YES
BEAM	MEDIUM
SCREEN	LENS
LED COLOUR	3000K CRI >90 LMN 615lm 1mt 3055lx 2mt 764lx 3mt 339lx
IP RATE	IP65
MATERIALS	BODY: ALUMINIUM HEATSINK: ALUMINUM
MOUNTING SYSTEM	WIRE SPRINGS
OPTIONAL LED COLOUR	2700K - 4000K

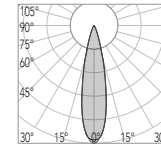

vegas 1 . 50



vegas 1 . 65

	FINISHES	FE	23	20	3
		I	23		



# vegas 2

## . 65

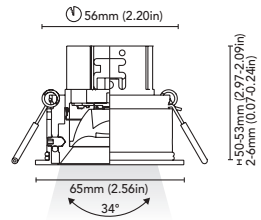

<b>CODE</b>	<b>3553-65-P6W</b>
<b>FIXTURE</b>	ADJUSTABLE DOWNLIGHT
<b>ADJUSTABILITY</b>	YES
<b>LIGHT SOURCE</b>	POWER LED
<b>POWER</b>	MAX 6W
<b>SUPPLY</b>	16-32Vdc - wired driver
<b>PROTECTION</b>	FUSE - POLARITY REVERSE SPIKE FILTER
<b>DIMMABLE</b>	YES
<b>BEAM</b>	MEDIUM
<b>SCREEN</b>	LENS
<b>LED COLOUR</b>	3000K CRI >90 LMN 623lm 1mt 2709lx 2mt 677lx 3mt 301lx
<b>IP RATE</b>	IP20
<b>MATERIALS</b>	BODY: ALUMINIUM HEATSINK: ALUMINUM
<b>MOUNTING SYSTEM</b>	WIRE SPRINGS
<b>OPTIONAL LED COLOUR</b>	2700K - 4000K

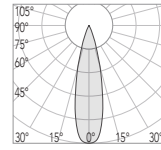

vegas 2 . 65

	<b>FINISHES</b>	<b>FE</b>	23 ● 20 ○ 3 ●
		<b>R</b>	23 ●



# memphis 1

. 50

. 65

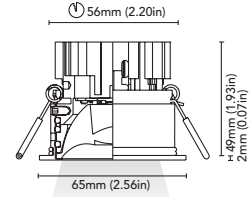
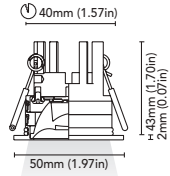

CODE	<b>3551-50-P4.5W</b>
FIXTURE	FIXED DOWNLIGHT
ADJUSTABILITY	NO
LIGHT SOURCE	POWER LED
POWER	MAX 4,5W
SUPPLY	16-32Vdc - wired driver
PROTECTION	FUSE - POLARITY REVERSE SPIKE FILTER
DIMMABLE	YES
BEAM	MEDIUM
SCREEN	LENS
LED COLOUR	3000K CRI >90 LMN 435lm 1mt 1919lx 2mt 480lx 3mt 213lx
IP RATE	IP65
MATERIALS	BODY: ALUMINIUM HEATSINK: ALUMINUM
MOUNTING SYSTEM	WIRE SPRINGS
OPTIONAL	
LED COLOUR	2700K - 4000K

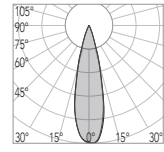

CODE	<b>3551-65-P6W</b>
FIXTURE	FIXED DOWNLIGHT
ADJUSTABILITY	NO
LIGHT SOURCE	POWER LED
POWER	MAX 6W
SUPPLY	16-32Vdc - wired driver
PROTECTION	FUSE - POLARITY REVERSE SPIKE FILTER
DIMMABLE	YES
BEAM	MEDIUM
SCREEN	LENS
LED COLOUR	3000K CRI >90 LMN 645lm 1mt 4879lx 2mt 1220lx 3mt 542lx
IP RATE	IP65
MATERIALS	BODY: ALUMINIUM HEATSINK: ALUMINUM
MOUNTING SYSTEM	WIRE SPRINGS
OPTIONAL	
LED COLOUR	2700K - 4000K

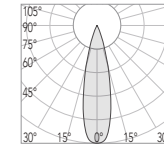

memphis 1 . 50



memphis 1 . 65



FINISHES	<b>FE</b>	23 20 3
		● ○ ●



# ocean

## . 105

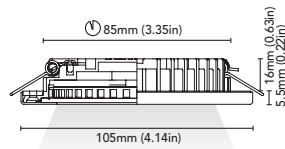

## . 130

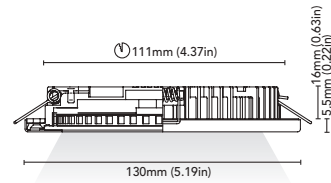

## . 155

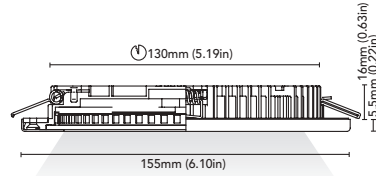

## . 210

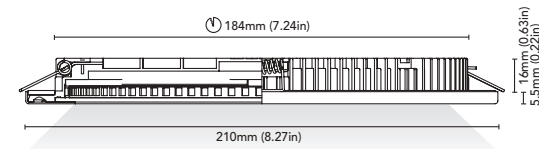

<b>CODE</b>	<b>3479-105A-B8W</b> <b>3479-105C-B8W</b>
<b>FIXTURE</b>	FIXED CEILING LAMP
<b>ADJUSTABILITY</b>	NO
<b>LIGHT SOURCE</b>	LED
<b>POWER</b>	MAX 8W
<b>SUPPLY</b>	16-32 Vdc
<b>PROTECTION</b>	POLARITY REVERSE
<b>DIMMABLE</b>	YES
<b>BEAM</b>	WIDE
<b>SCREEN</b>	OPAL
<b>LED COLOUR</b>	3000K CRI >90 LMN 423lm 1mt 154lx 2mt 38lx 3mt 17lx
<b>IP RATE</b>	IP66
<b>MATERIALS</b>	BODY: STAINLESS STEEL AISI 316 HEATSINK: SPECIAL COMPOUND
<b>MOUNTING SYSTEM</b>	(A) WIRE SPRINGS (C) SCREWS
<b>OPTIONAL</b>	
<b>LED COLOUR</b>	2700K - 4000K

<b>CODE</b>	<b>3479-130A-B10W</b> <b>3479-130C-B10W</b>
<b>FIXTURE</b>	FIXED CEILING LAMP
<b>ADJUSTABILITY</b>	NO
<b>LIGHT SOURCE</b>	LED
<b>POWER</b>	MAX 10W
<b>SUPPLY</b>	16-32 Vdc
<b>PROTECTION</b>	POLARITY REVERSE
<b>DIMMABLE</b>	YES
<b>BEAM</b>	WIDE
<b>SCREEN</b>	OPAL
<b>LED COLOUR</b>	3000K CRI >90 LMN 523lm 1mt 190lx 2mt 48lx 3mt 21lx
<b>IP RATE</b>	IP66
<b>MATERIALS</b>	BODY: STAINLESS STEEL AISI 316 HEATSINK: SPECIAL COMPOUND
<b>MOUNTING SYSTEM</b>	(A) WIRE SPRINGS (C) SCREWS
<b>OPTIONAL</b>	
<b>LED COLOUR</b>	2700K - 4000K

<b>CODE</b>	<b>3479-155A-B12W</b> <b>3479-155C-B12W</b>
<b>FIXTURE</b>	FIXED CEILING LAMP
<b>ADJUSTABILITY</b>	NO
<b>LIGHT SOURCE</b>	LED
<b>POWER</b>	MAX 12W
<b>SUPPLY</b>	16-32 Vdc
<b>PROTECTION</b>	POLARITY REVERSE
<b>DIMMABLE</b>	YES
<b>BEAM</b>	WIDE
<b>SCREEN</b>	OPAL
<b>LED COLOUR</b>	3000K CRI >90 LMN 665lm 1mt 242lx 2mt 61lx 3mt 27lx
<b>IP RATE</b>	IP66
<b>MATERIALS</b>	BODY: STAINLESS STEEL AISI 316 HEATSINK: SPECIAL COMPOUND
<b>MOUNTING SYSTEM</b>	(A) WIRE SPRINGS (C) SCREWS
<b>OPTIONAL</b>	
<b>LED COLOUR</b>	2700K - 4000K

<b>CODE</b>	<b>3479-210A-B18W</b> <b>3479-210C-B18W</b>
<b>FIXTURE</b>	FIXED CEILING LAMP
<b>ADJUSTABILITY</b>	NO
<b>LIGHT SOURCE</b>	LED
<b>POWER</b>	MAX 18W
<b>SUPPLY</b>	16-32 Vdc
<b>PROTECTION</b>	POLARITY REVERSE
<b>DIMMABLE</b>	YES
<b>BEAM</b>	WIDE
<b>SCREEN</b>	OPAL
<b>LED COLOUR</b>	3000K CRI >90 LMN 1142lm 1mt 416lx 2mt 104lx 3mt 46lx
<b>IP RATE</b>	IP66
<b>MATERIALS</b>	BODY: STAINLESS STEEL AISI 316 HEATSINK: SPECIAL COMPOUND
<b>MOUNTING SYSTEM</b>	(A) WIRE SPRINGS (C) SCREWS
<b>OPTIONAL</b>	
<b>LED COLOUR</b>	2700K - 4000K

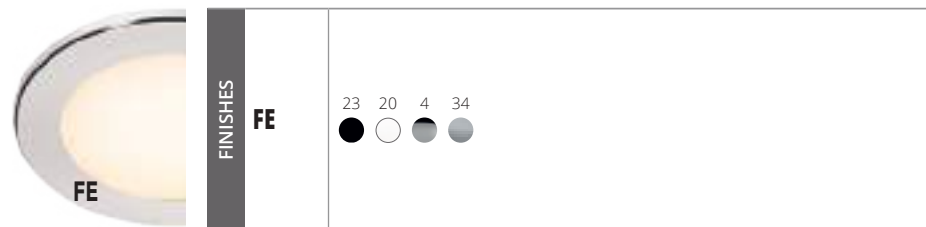

ocean - 105, 130, 155, 210

# ring

CODE	<b>9000-RING130</b> X OCEAN 105 <b>9000-RING155</b> X OCEAN 130 <b>9000-RING180</b> X OCEAN 155 <b>9000-RING235</b> X OCEAN 210
FIXTURE	FRAME FOR OCEAN SERIES
MATERIALS	STAINLESS STEEL AISI 316
MOUNTING SYSTEM	SCREWS

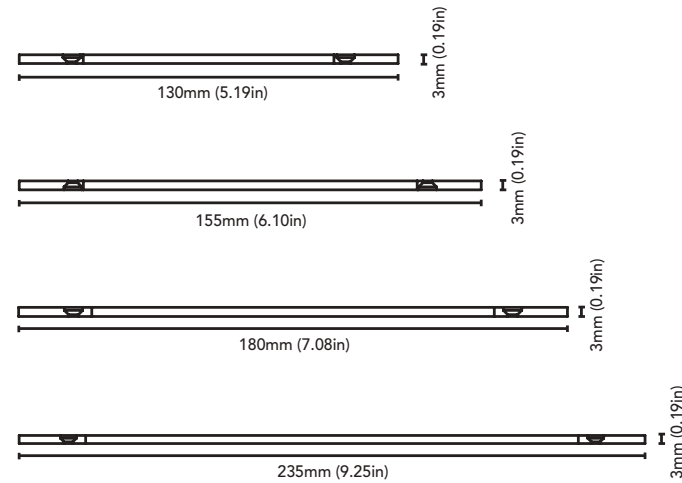

ring - 130, 155, 180, 235



ocean - 105 frame ring - 130

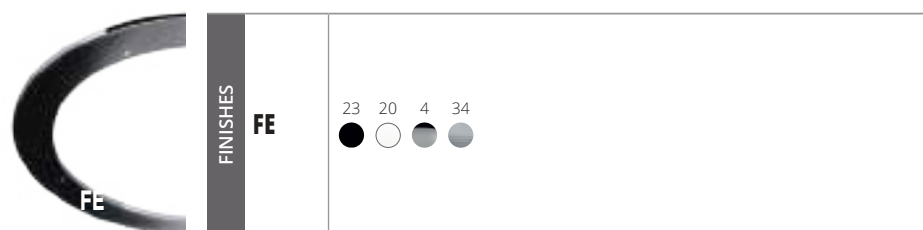



# malibù

. 60

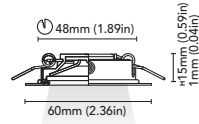

. 75

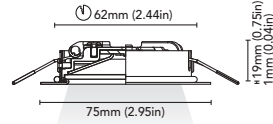

. 85

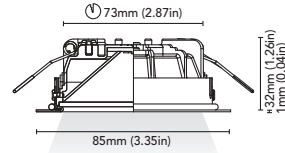

. 95

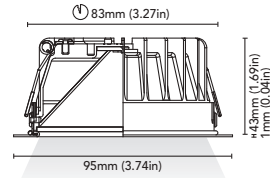

<b>CODE</b>	<b>3412-60A-B1.5W</b>
<b>FIXTURE</b>	FIXED DOWNLIGHT
<b>ADJUSTABILITY</b>	NO
<b>LIGHT SOURCE</b>	POWER LED
<b>POWER</b>	MAX 1,5W
<b>SUPPLY</b>	8-32 Vdc
<b>PROTECTION</b>	FUSE - POLARITY REVERSE SPIKE FILTER
<b>DIMMABLE</b>	YES
<b>BEAM</b>	WIDE
<b>SCREEN</b>	OPAL
<b>LED COLOUR</b>	3000K CRI >90 LMN 109lm 1mt 46lx 2mt 12lx 3mt 5lx 
<b>IP RATE</b>	IP66
<b>MATERIALS</b>	BODY: STAINLESS STEEL AISI 316 HEATSINK: SPECIAL COMPOUND
<b>MOUNTING SYSTEM</b>	WIRE SPRINGS
<b>OPTIONAL LED COLOUR</b>	2700K - 4000K - RED - BLUE

<b>CODE</b>	<b>3412-75A-B2W</b>
<b>FIXTURE</b>	FIXED DOWNLIGHT
<b>ADJUSTABILITY</b>	NO
<b>LIGHT SOURCE</b>	POWER LED
<b>POWER</b>	MAX 2W
<b>SUPPLY</b>	8-32 Vdc
<b>PROTECTION</b>	FUSE - POLARITY REVERSE SPIKE FILTER
<b>DIMMABLE</b>	YES
<b>BEAM</b>	WIDE
<b>SCREEN</b>	OPAL
<b>LED COLOUR</b>	3000K CRI >90 LMN 191lm 1mt 77lx 2mt 19lx 3mt 9lx 
<b>IP RATE</b>	IP66
<b>MATERIALS</b>	BODY: STAINLESS STEEL AISI 316 HEATSINK: SPECIAL COMPOUND
<b>MOUNTING SYSTEM</b>	WIRE SPRINGS
<b>OPTIONAL LED COLOUR</b>	2700K - 4000K - (3000K+RED)

<b>CODE</b>	<b>3412-85A-B4W</b>
<b>FIXTURE</b>	FIXED DOWNLIGHT
<b>ADJUSTABILITY</b>	NO
<b>LIGHT SOURCE</b>	POWER LED
<b>POWER</b>	MAX 4W
<b>SUPPLY</b>	8-32 Vdc
<b>PROTECTION</b>	FUSE - POLARITY REVERSE SPIKE FILTER
<b>DIMMABLE</b>	YES
<b>BEAM</b>	WIDE
<b>SCREEN</b>	OPAL
<b>LED COLOUR</b>	3000K CRI >90 LMN 330lm 1mt 143lx 2mt 36lx 3mt 16lx 
<b>IP RATE</b>	IP66
<b>MATERIALS</b>	BODY: STAINLESS STEEL AISI 316 HEATSINK: SPECIAL COMPOUND
<b>MOUNTING SYSTEM</b>	WIRE SPRINGS
<b>OPTIONAL LED COLOUR</b>	2700K - 4000K - (3000K+RED)

<b>CODE</b>	<b>3412-95A-B6W</b>
<b>FIXTURE</b>	FIXED DOWNLIGHT
<b>ADJUSTABILITY</b>	NO
<b>LIGHT SOURCE</b>	POWER LED
<b>POWER</b>	MAX 6W
<b>SUPPLY</b>	8-32 Vdc
<b>PROTECTION</b>	FUSE - POLARITY REVERSE SPIKE FILTER
<b>DIMMABLE</b>	YES
<b>BEAM</b>	WIDE
<b>SCREEN</b>	OPAL
<b>LED COLOUR</b>	3000K CRI >90 LMN 399lm 1mt 178lx 2mt 45lx 3mt 20lx 
<b>IP RATE</b>	IP66
<b>MATERIALS</b>	BODY: STAINLESS STEEL AISI 316 HEATSINK: SPECIAL COMPOUND
<b>MOUNTING SYSTEM</b>	WIRE SPRINGS
<b>OPTIONAL LED COLOUR</b>	2700K - 4000K - (3000K+RED)



malibù - 60, 75, 85, 95



**FINISHES**

**FE**

23 20 4 34





# malibù r

. 60

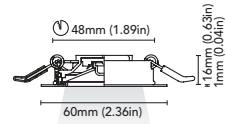

. 75

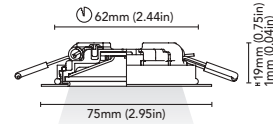

. 85

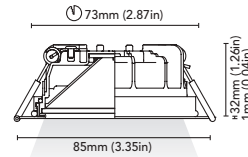

. 95

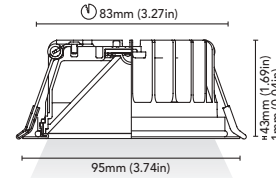

<b>CODE</b>	<b>3546-60A-B1.5W</b>
<b>FIXTURE</b>	FIXED DOWNLIGHT
<b>ADJUSTABILITY</b>	NO
<b>LIGHT SOURCE</b>	POWER LED
<b>POWER</b>	MAX 1,5W
<b>SUPPLY</b>	8-32 Vdc
<b>PROTECTION</b>	FUSE - POLARITY REVERSE SPIKE FILTER
<b>DIMMABLE</b>	YES
<b>BEAM</b>	WIDE
<b>SCREEN</b>	OPAL
<b>LED COLOUR</b>	3000K CRI >90 LMN 109lm 1mt 46lx 2mt 12lx 3mt 5lx
<b>IP RATE</b>	IP66
<b>MATERIALS</b>	BODY: STAINLESS STEEL AISI 316 HEATSINK: SPECIAL COMPOUND
<b>MOUNTING SYSTEM</b>	WIRE SPRINGS
<b>OPTIONAL LED COLOUR</b>	2700K - 4000K - RED - BLUE

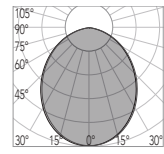

<b>CODE</b>	<b>3546-75A-B2W</b>
<b>FIXTURE</b>	FIXED DOWNLIGHT
<b>ADJUSTABILITY</b>	NO
<b>LIGHT SOURCE</b>	POWER LED
<b>POWER</b>	MAX 2W
<b>SUPPLY</b>	8-32 Vdc
<b>PROTECTION</b>	FUSE - POLARITY REVERSE SPIKE FILTER
<b>DIMMABLE</b>	YES
<b>BEAM</b>	WIDE
<b>SCREEN</b>	OPAL
<b>LED COLOUR</b>	3000K CRI >90 LMN 191lm 1mt 77lx 2mt 19lx 3mt 9lx
<b>IP RATE</b>	IP66
<b>MATERIALS</b>	BODY: STAINLESS STEEL AISI 316 HEATSINK: SPECIAL COMPOUND
<b>MOUNTING SYSTEM</b>	WIRE SPRINGS
<b>OPTIONAL LED COLOUR</b>	2700K - 4000K - (3000K+RED)

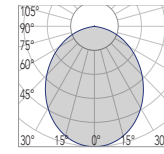

<b>CODE</b>	<b>3546-85A-B4W</b>
<b>FIXTURE</b>	FIXED DOWNLIGHT
<b>ADJUSTABILITY</b>	NO
<b>LIGHT SOURCE</b>	POWER LED
<b>POWER</b>	MAX 4W
<b>SUPPLY</b>	8-32 Vdc
<b>PROTECTION</b>	FUSE - POLARITY REVERSE SPIKE FILTER
<b>DIMMABLE</b>	YES
<b>BEAM</b>	WIDE
<b>SCREEN</b>	OPAL
<b>LED COLOUR</b>	3000K CRI >90 LMN 330lm 1mt 143lx 2mt 36lx 3mt 16lx
<b>IP RATE</b>	IP66
<b>MATERIALS</b>	BODY: STAINLESS STEEL AISI 316 HEATSINK: SPECIAL COMPOUND
<b>MOUNTING SYSTEM</b>	WIRE SPRINGS
<b>OPTIONAL LED COLOUR</b>	2700K - 4000K - (3000K+RED)

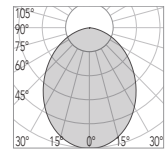

<b>CODE</b>	<b>3546-95A-B6W</b>
<b>FIXTURE</b>	FIXED DOWNLIGHT
<b>ADJUSTABILITY</b>	NO
<b>LIGHT SOURCE</b>	POWER LED
<b>POWER</b>	MAX 6W
<b>SUPPLY</b>	8-32 Vdc
<b>PROTECTION</b>	FUSE - POLARITY REVERSE SPIKE FILTER
<b>DIMMABLE</b>	YES
<b>BEAM</b>	WIDE
<b>SCREEN</b>	OPAL
<b>LED COLOUR</b>	3000K CRI >90 LMN 399lm 1mt 178lx 2mt 45lx 3mt 20lx
<b>IP RATE</b>	IP66
<b>MATERIALS</b>	BODY: STAINLESS STEEL AISI 316 HEATSINK: SPECIAL COMPOUND
<b>MOUNTING SYSTEM</b>	WIRE SPRINGS
<b>OPTIONAL LED COLOUR</b>	2700K - 4000K - (3000K+RED)

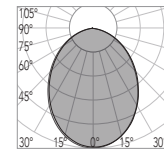

NEW UNSCREWABLE FLANGE ENABLING EASY REPLACEMENT AND CHANGE OF APPEARANCE



malibù r - 60, 75, 85, 95



**FINISHES**

**FE**

23 20 4 34





# newport

. 85

. 95

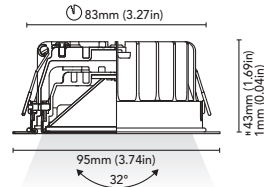
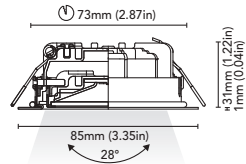

<b>CODE</b>	<b>3414-85A-B2W</b>
<b>FIXTURE</b>	ADJUSTABLE DOWNLIGHT
<b>ADJUSTABILITY</b>	△ 28°
<b>LIGHT SOURCE</b>	POWER LED
<b>POWER</b>	MAX 2W
<b>SUPPLY</b>	8-32 Vdc
<b>PROTECTION</b>	FUSE - POLARITY REVERSE SPIKE FILTER
<b>DIMMABLE</b>	YES
<b>BEAM</b>	WIDE
<b>SCREEN</b>	OPAL
<b>LED COLOUR</b>	3000K CRI >90 LMN 191lm 1mt 77lx 2mt 19x 3mt 9x
<b>IP RATE</b>	IP66
<b>MATERIALS</b>	BODY: STAINLESS STEEL AISI 316 HEATSINK: SPECIAL COMPOUND
<b>MOUNTING SYSTEM</b>	WIRE SPRINGS
<b>OPTIONAL LED COLOUR</b>	2700K - 4000K - (3000K+RED)

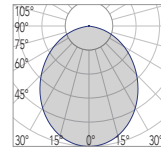

<b>CODE</b>	<b>3414-95A-B4W</b>
<b>FIXTURE</b>	ADJUSTABLE DOWNLIGHT
<b>ADJUSTABILITY</b>	△ 32°
<b>LIGHT SOURCE</b>	POWER LED
<b>POWER</b>	MAX 4W
<b>SUPPLY</b>	8-32 Vdc
<b>PROTECTION</b>	FUSE - POLARITY REVERSE SPIKE FILTER
<b>DIMMABLE</b>	YES
<b>BEAM</b>	WIDE
<b>SCREEN</b>	OPAL
<b>LED COLOUR</b>	3000K CRI >90 LMN 330lm 1mt 143lx 2mt 36lx 3mt 16lx
<b>IP RATE</b>	IP66
<b>MATERIALS</b>	BODY: STAINLESS STEEL AISI 316 HEATSINK: SPECIAL COMPOUND
<b>MOUNTING SYSTEM</b>	WIRE SPRINGS
<b>OPTIONAL LED COLOUR</b>	2700K - 4000K - (3000K+RED)

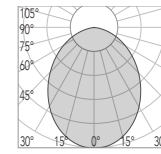

newport - 85, 95

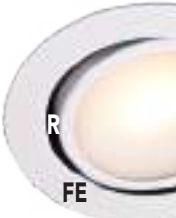

<b>FINISHES</b>	<b>R=FE</b>	23 20 4 34



# newport r

. 85

. 95

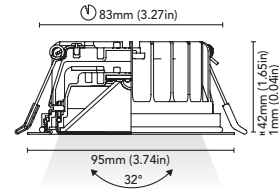
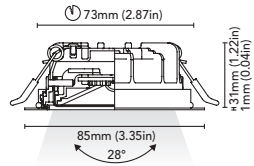

<b>CODE</b>	<b>3547-85A-B2W</b>
<b>FIXTURE</b>	ADJUSTABLE DOWNLIGHT
<b>ADJUSTABILITY</b>	△ 28°
<b>LIGHT SOURCE</b>	POWER LED
<b>POWER</b>	MAX 2W
<b>SUPPLY</b>	8-32 Vdc
<b>PROTECTION</b>	FUSE - POLARITY REVERSE SPIKE FILTER
<b>DIMMABLE</b>	YES
<b>BEAM</b>	WIDE
<b>SCREEN</b>	OPAL
<b>LED COLOUR</b>	3000K CRI >90 LMN 191lm 1mt 77lx 2mt 19x 3mt 9x
<b>IP RATE</b>	IP66
<b>MATERIALS</b>	BODY: STAINLESS STEEL AISI 316 HEATSINK: SPECIAL COMPOUND
<b>MOUNTING SYSTEM</b>	WIRE SPRINGS
<b>OPTIONAL</b>	
<b>LED COLOUR</b>	2700K - 4000K - (3000K+RED)

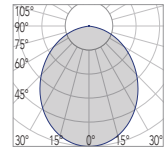

<b>CODE</b>	<b>3547-95A-B4W</b>
<b>FIXTURE</b>	ADJUSTABLE DOWNLIGHT
<b>ADJUSTABILITY</b>	△ 32°
<b>LIGHT SOURCE</b>	POWER LED
<b>POWER</b>	MAX 4W
<b>SUPPLY</b>	8-32 Vdc
<b>PROTECTION</b>	FUSE - POLARITY REVERSE SPIKE FILTER
<b>DIMMABLE</b>	YES
<b>BEAM</b>	WIDE
<b>SCREEN</b>	OPAL
<b>LED COLOUR</b>	3000K CRI >90 LMN 330lm 1mt 143lx 2mt 36lx 3mt 16lx
<b>IP RATE</b>	IP66
<b>MATERIALS</b>	BODY: STAINLESS STEEL AISI 316 HEATSINK: SPECIAL COMPOUND
<b>MOUNTING SYSTEM</b>	WIRE SPRINGS
<b>OPTIONAL</b>	
<b>LED COLOUR</b>	2700K - 4000K - (3000K+RED)

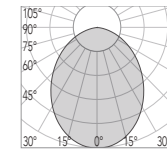

NEW UNSCREWABLE FLANGE ENABLING EASY REPLACEMENT AND CHANGE OF APPEARANCE



newport r - 85, 95

**FINISHES**

**R=FE**

23 20 4 34



# orlando

. 60

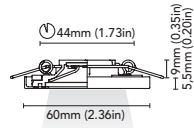

. 75

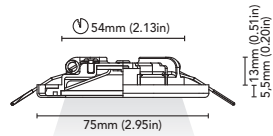

. 85

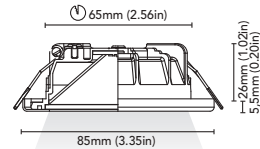

. 95

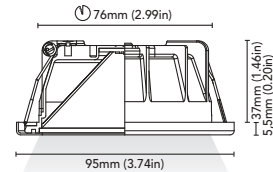

CODE	<b>3406-60A-B1.5W</b> <b>3406-60C-B1.5W</b>
FIXTURE	FIXED DOWNLIGHT
ADJUSTABILITY	NO
LIGHT SOURCE	POWER LED
POWER	MAX 1,5W
SUPPLY	8-32 Vdc
PROTECTION	FUSE - POLARITY REVERSE SPIKE FILTER
DIMMABLE	YES
BEAM	WIDE
SCREEN	OPAL
LED COLOUR	3000K CRI >90 LMN 109lm 1mt 46lx 2mt 12lx 3mt 5lx
IP RATE	IP66
MATERIALS	BODY: STAINLESS STEEL AISI 316 HEATSINK: SPECIAL COMPOUND
MOUNTING SYSTEM	(A) WIRE SPRINGS (C) SCREWS
OPTIONAL	
SWITCH ON THE FRAME	
LED COLOUR	2700K - 4000K - RED - BLUE

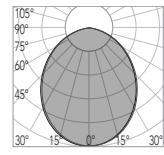

CODE	<b>3406-75A-B2W</b> <b>3406-75C-B2W</b>
FIXTURE	FIXED DOWNLIGHT
ADJUSTABILITY	NO
LIGHT SOURCE	POWER LED
POWER	MAX 2W
SUPPLY	8-32 Vdc
PROTECTION	FUSE - POLARITY REVERSE SPIKE FILTER
DIMMABLE	YES
BEAM	WIDE
SCREEN	OPAL
LED COLOUR	3000K CRI >90 LMN 191lm 1mt 77lx 2mt 19lx 3mt 9lx
IP RATE	IP66
MATERIALS	BODY: STAINLESS STEEL AISI 316 HEATSINK: SPECIAL COMPOUND
MOUNTING SYSTEM	(A) WIRE SPRINGS (C) SCREWS
OPTIONAL	
SWITCH ON THE FRAME	AVAILABLE
LED COLOUR	2700K - 4000K - (3000K+RED)

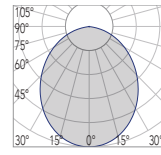

CODE	<b>3406-85A-B4W</b> <b>3406-85C-B4W</b>
FIXTURE	FIXED DOWNLIGHT
ADJUSTABILITY	NO
LIGHT SOURCE	POWER LED
POWER	MAX 4W
SUPPLY	8-32 Vdc
PROTECTION	FUSE - POLARITY REVERSE SPIKE FILTER
DIMMABLE	YES
BEAM	WIDE
SCREEN	OPAL
LED COLOUR	3000K CRI >90 LMN 330lm 1mt 143lx 2mt 36lx 3mt 16lx
IP RATE	IP66
MATERIALS	BODY: STAINLESS STEEL AISI 316 HEATSINK: SPECIAL COMPOUND
MOUNTING SYSTEM	(A) WIRE SPRINGS (C) SCREWS
OPTIONAL	
SWITCH ON THE FRAME	AVAILABLE
LED COLOUR	2700K - 4000K - (3000K+RED)

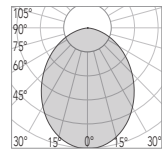

CODE	<b>3406-95A-B6W</b> <b>3406-95C-B6W</b>
FIXTURE	FIXED DOWNLIGHT
ADJUSTABILITY	NO
LIGHT SOURCE	POWER LED
POWER	MAX 6W
SUPPLY	8-32 Vdc
PROTECTION	FUSE - POLARITY REVERSE SPIKE FILTER
DIMMABLE	YES
BEAM	WIDE
SCREEN	OPAL
LED COLOUR	3000K CRI >90 LMN 399lm 1mt 178lx 2mt 45lx 3mt 20lx
IP RATE	IP66
MATERIALS	BODY: STAINLESS STEEL AISI 316 HEATSINK: SPECIAL COMPOUND
MOUNTING SYSTEM	(A) WIRE SPRINGS (C) SCREWS
OPTIONAL	
SWITCH ON THE FRAME	AVAILABLE
LED COLOUR	2700K - 4000K - (3000K+RED)

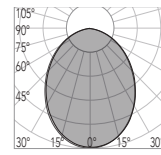

orlando - 60, 75, 85, 95



FINISHES	<b>FE</b>	23 20 4 34

switch on the frame





# phoenix

. 85

. 95

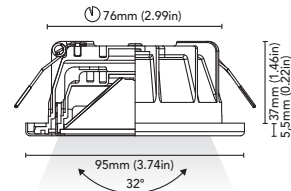
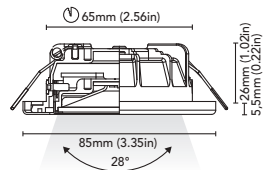

CODE	<b>3408-85A-B2W</b> <b>3408-85C-B2W</b>
FIXTURE	ADJUSTABLE DOWNLIGHT
ADJUSTABILITY	△ 28°
LIGHT SOURCE	POWER LED
POWER	MAX 2W
SUPPLY	8-32 Vdc
PROTECTION	FUSE - POLARITY REVERSE SPIKE FILTER
DIMMABLE	YES
BEAM	WIDE
SCREEN	OPAL
LED COLOUR	3000K CRI >90 LMN 191lm 1mt 77lx 2mt 19x 3mt 9x
IP RATE	IP66
MATERIALS	BODY: STAINLESS STEEL AISI 316 HEATSINK: SPECIAL COMPOUND
MOUNTING SYSTEM	(A) WIRE SPRINGS (C) SCREWS
OPTIONAL SWITCH ON THE FRAME	AVAILABLE
LED COLOUR	2700K - 4000K - (3000K+RED)

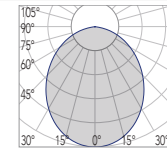

CODE	<b>3408-95A-B4W</b> <b>3408-95C-B4W</b>
FIXTURE	ADJUSTABLE DOWNLIGHT
ADJUSTABILITY	△ 32°
LIGHT SOURCE	POWER LED
POWER	MAX 4W
SUPPLY	8-32 Vdc
PROTECTION	FUSE - POLARITY REVERSE SPIKE FILTER
DIMMABLE	YES
BEAM	WIDE
SCREEN	OPAL
LED COLOUR	3000K CRI >90 LMN 330lm 1mt 143lx 2mt 36lx 3mt 16lx
IP RATE	IP66
MATERIALS	BODY: STAINLESS STEEL AISI 316 HEATSINK: SPECIAL COMPOUND
MOUNTING SYSTEM	(A) WIRE SPRINGS (C) SCREWS
OPTIONAL SWITCH ON THE FRAME	AVAILABLE
LED COLOUR	2700K - 4000K - (3000K+RED)

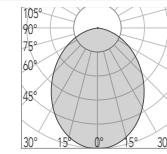

phoenix - 85, 95



FINISHES	<b>FE=R</b>
	23 20 4 34
	● ○ ● ●

switch on the frame





# seattle

. 55

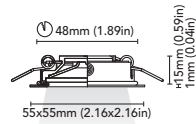

. 70

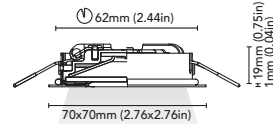

. 80

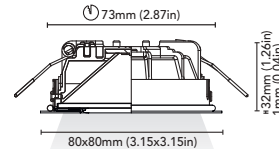

. 90

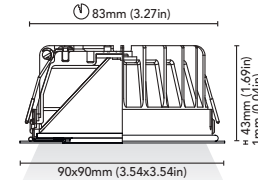

<b>CODE</b>	<b>3413-55A-B1.5W</b>
<b>FIXTURE</b>	FIXED DOWNLIGHT
<b>ADJUSTABILITY</b>	NO
<b>LIGHT SOURCE</b>	POWER LED
<b>POWER</b>	MAX 1,5W
<b>SUPPLY</b>	8-32 Vdc
<b>PROTECTION</b>	FUSE - POLARITY REVERSE SPIKE FILTER
<b>DIMMABLE</b>	YES
<b>BEAM</b>	WIDE
<b>SCREEN</b>	OPAL
<b>LED COLOUR</b>	3000K CRI >90 LMN 109lm 1mt 46lx 2mt 12lx 3mt 5lx
<b>IP RATE</b>	IP66
<b>MATERIALS</b>	BODY: STAINLESS STEEL AISI 316 HEATSINK: SPECIAL COMPOUND
<b>MOUNTING SYSTEM</b>	WIRE SPRINGS
<b>OPTIONAL LED COLOUR</b>	2700K - 4000K - RED - BLUE

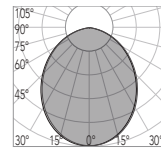

<b>CODE</b>	<b>3413-70A-B2W</b>
<b>FIXTURE</b>	FIXED DOWNLIGHT
<b>ADJUSTABILITY</b>	NO
<b>LIGHT SOURCE</b>	POWER LED
<b>POWER</b>	MAX 2W
<b>SUPPLY</b>	8-32 Vdc
<b>PROTECTION</b>	FUSE - POLARITY REVERSE SPIKE FILTER
<b>DIMMABLE</b>	YES
<b>BEAM</b>	WIDE
<b>SCREEN</b>	OPAL
<b>LED COLOUR</b>	3000K CRI >90 LMN 191lm 1mt 77lx 2mt 19lx 3mt 9lx
<b>IP RATE</b>	IP66
<b>MATERIALS</b>	BODY: STAINLESS STEEL AISI 316 HEATSINK: SPECIAL COMPOUND
<b>MOUNTING SYSTEM</b>	WIRE SPRINGS
<b>OPTIONAL LED COLOUR</b>	2700K - 4000K - (3000K+RED)

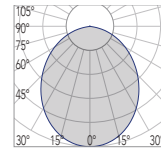

<b>CODE</b>	<b>3413-80A-B4W</b>
<b>FIXTURE</b>	FIXED DOWNLIGHT
<b>ADJUSTABILITY</b>	NO
<b>LIGHT SOURCE</b>	POWER LED
<b>POWER</b>	MAX 4W
<b>SUPPLY</b>	8-32 Vdc
<b>PROTECTION</b>	FUSE - POLARITY REVERSE SPIKE FILTER
<b>DIMMABLE</b>	YES
<b>BEAM</b>	WIDE
<b>SCREEN</b>	OPAL
<b>LED COLOUR</b>	3000K CRI >90 LMN 330lm 1mt 143lx 2mt 36lx 3mt 16lx
<b>IP RATE</b>	IP66
<b>MATERIALS</b>	BODY: STAINLESS STEEL AISI 316 HEATSINK: SPECIAL COMPOUND
<b>MOUNTING SYSTEM</b>	WIRE SPRINGS
<b>OPTIONAL LED COLOUR</b>	2700K - 4000K - (3000K+RED)

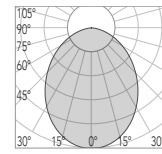

<b>CODE</b>	<b>3413-90A-B6W</b>
<b>FIXTURE</b>	FIXED DOWNLIGHT
<b>ADJUSTABILITY</b>	NO
<b>LIGHT SOURCE</b>	POWER LED
<b>POWER</b>	MAX 6W
<b>SUPPLY</b>	8-32 Vdc
<b>PROTECTION</b>	FUSE - POLARITY REVERSE SPIKE FILTER
<b>DIMMABLE</b>	YES
<b>BEAM</b>	WIDE
<b>SCREEN</b>	OPAL
<b>LED COLOUR</b>	3000K CRI >90 LMN 399lm 1mt 178lx 2mt 45lx 3mt 20lx
<b>IP RATE</b>	IP66
<b>MATERIALS</b>	BODY: STAINLESS STEEL AISI 316 HEATSINK: SPECIAL COMPOUND
<b>MOUNTING SYSTEM</b>	WIRE SPRINGS
<b>OPTIONAL LED COLOUR</b>	2700K - 4000K - (3000K+RED)

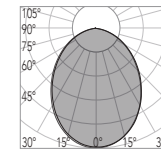

seattle - 55, 70, 80, 90

FINISHES

FE

23

20

4

34



# seattle r

. 55

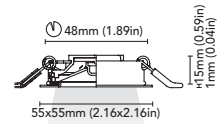

. 70

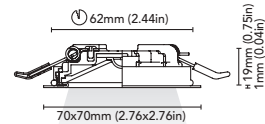

. 80

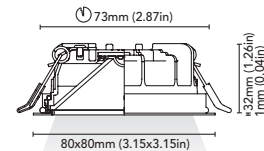

. 90

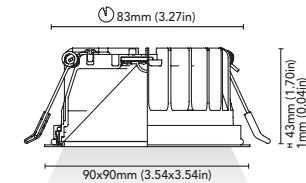

<b>CODE</b>	<b>3549-55A-B1.5W</b>
<b>FIXTURE</b>	FIXED DOWNLIGHT
<b>ADJUSTABILITY</b>	NO
<b>LIGHT SOURCE</b>	POWER LED
<b>POWER</b>	MAX 1,5W
<b>SUPPLY</b>	8-32 Vdc
<b>PROTECTION</b>	FUSE - POLARITY REVERSE SPIKE FILTER
<b>DIMMABLE</b>	YES
<b>BEAM</b>	WIDE
<b>SCREEN</b>	OPAL
<b>LED COLOUR</b>	3000K CRI >90 LMN 109lm 1mt 46lx 2mt 12lx 3mt 5lx
<b>IP RATE</b>	IP66
<b>MATERIALS</b>	BODY: STAINLESS STEEL AISI 316 HEATSINK: SPECIAL COMPOUND
<b>MOUNTING SYSTEM</b>	WIRE SPRINGS
<b>OPTIONAL LED COLOUR</b>	2700K - 4000K - RED - BLUE

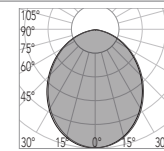

<b>CODE</b>	<b>3549-70A-B2W</b>
<b>FIXTURE</b>	FIXED DOWNLIGHT
<b>ADJUSTABILITY</b>	NO
<b>LIGHT SOURCE</b>	POWER LED
<b>POWER</b>	MAX 2W
<b>SUPPLY</b>	8-32 Vdc
<b>PROTECTION</b>	FUSE - POLARITY REVERSE SPIKE FILTER
<b>DIMMABLE</b>	YES
<b>BEAM</b>	WIDE
<b>SCREEN</b>	OPAL
<b>LED COLOUR</b>	3000K CRI >90 LMN 191lm 1mt 77lx 2mt 19lx 3mt 9lx
<b>IP RATE</b>	IP66
<b>MATERIALS</b>	BODY: STAINLESS STEEL AISI 316 HEATSINK: SPECIAL COMPOUND
<b>MOUNTING SYSTEM</b>	WIRE SPRINGS
<b>OPTIONAL LED COLOUR</b>	2700K - 4000K - (3000K+RED)

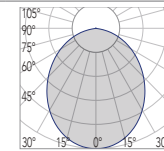

<b>CODE</b>	<b>3549-80A-B4W</b>
<b>FIXTURE</b>	FIXED DOWNLIGHT
<b>ADJUSTABILITY</b>	NO
<b>LIGHT SOURCE</b>	POWER LED
<b>POWER</b>	MAX 4W
<b>SUPPLY</b>	8-32 Vdc
<b>PROTECTION</b>	FUSE - POLARITY REVERSE SPIKE FILTER
<b>DIMMABLE</b>	YES
<b>BEAM</b>	WIDE
<b>SCREEN</b>	OPAL
<b>LED COLOUR</b>	3000K CRI >90 LMN 330lm 1mt 143lx 2mt 36lx 3mt 16lx
<b>IP RATE</b>	IP66
<b>MATERIALS</b>	BODY: STAINLESS STEEL AISI 316 HEATSINK: SPECIAL COMPOUND
<b>MOUNTING SYSTEM</b>	WIRE SPRINGS
<b>OPTIONAL LED COLOUR</b>	2700K - 4000K - (3000K+RED)

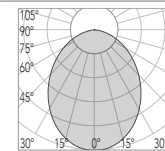

<b>CODE</b>	<b>3549-90A-B6W</b>
<b>FIXTURE</b>	FIXED DOWNLIGHT
<b>ADJUSTABILITY</b>	NO
<b>LIGHT SOURCE</b>	POWER LED
<b>POWER</b>	MAX 6W
<b>SUPPLY</b>	8-32 Vdc
<b>PROTECTION</b>	FUSE - POLARITY REVERSE SPIKE FILTER
<b>DIMMABLE</b>	YES
<b>BEAM</b>	WIDE
<b>SCREEN</b>	OPAL
<b>LED COLOUR</b>	3000K CRI >90 LMN 399lm 1mt 178lx 2mt 45lx 3mt 20lx
<b>IP RATE</b>	IP66
<b>MATERIALS</b>	BODY: STAINLESS STEEL AISI 316 HEATSINK: SPECIAL COMPOUND
<b>MOUNTING SYSTEM</b>	WIRE SPRINGS
<b>OPTIONAL LED COLOUR</b>	2700K - 4000K - (3000K+RED)

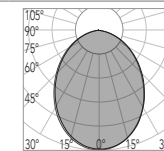

NEW UNSCREWABLE FLANGE ENABLING EASY REPLACEMENT AND CHANGE OF APPEARANCE



seattle r - 55, 70, 80, 90

**FINISHES**

**FE**

23 20 4 34



# atlanta

. 80

. 90

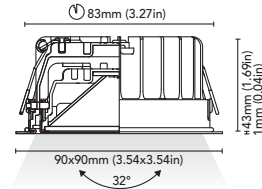
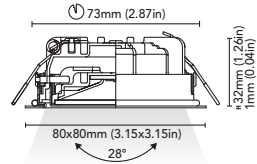

<b>CODE</b>	<b>3415-80A-B2W</b>
<b>FIXTURE</b>	ADJUSTABLE DOWNLIGHT
<b>ADJUSTABILITY</b>	△ 28°
<b>LIGHT SOURCE</b>	POWER LED
<b>POWER</b>	MAX 2W
<b>SUPPLY</b>	8-32 Vdc
<b>PROTECTION</b>	FUSE - POLARITY REVERSE SPIKE FILTER
<b>DIMMABLE</b>	YES
<b>BEAM</b>	WIDE
<b>SCREEN</b>	OPAL
<b>LED COLOUR</b>	3000K CRI >90 LMN 191lm 1mt 77lx 2mt 19x 3mt 9x
<b>IP RATE</b>	IP66
<b>MATERIALS</b>	BODY: STAINLESS STEEL AISI 316 HEATSINK: SPECIAL COMPOUND
<b>MOUNTING SYSTEM</b>	WIRE SPRINGS
<b>OPTIONAL LED COLOUR</b>	2700K - 4000K - (3000K+RED)

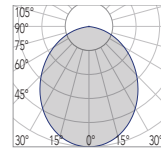

<b>CODE</b>	<b>3415-90A-B4W</b>
<b>FIXTURE</b>	ADJUSTABLE DOWNLIGHT
<b>ADJUSTABILITY</b>	△ 32°
<b>LIGHT SOURCE</b>	POWER LED
<b>POWER</b>	MAX 4W
<b>SUPPLY</b>	8-32 Vdc
<b>PROTECTION</b>	FUSE - POLARITY REVERSE SPIKE FILTER
<b>DIMMABLE</b>	YES
<b>BEAM</b>	WIDE
<b>SCREEN</b>	OPAL
<b>LED COLOUR</b>	3000K CRI >90 LMN 330lm 1mt 143lx 2mt 36lx 3mt 16lx
<b>IP RATE</b>	IP66
<b>MATERIALS</b>	BODY: STAINLESS STEEL AISI 316 HEATSINK: SPECIAL COMPOUND
<b>MOUNTING SYSTEM</b>	WIRE SPRINGS
<b>OPTIONAL LED COLOUR</b>	2700K - 4000K - (3000K+RED)

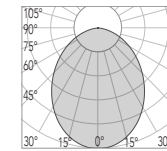

atlanta - 80, 90

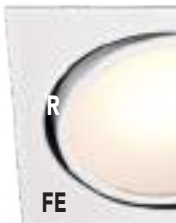

**FINISHES**

**R=FE**



# atlanta r

. 80

. 90

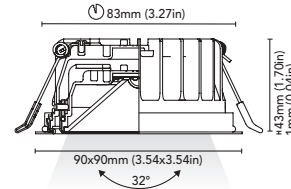
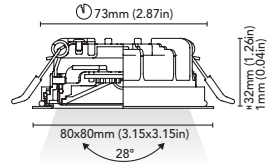

<b>CODE</b>	<b>3550-80A-B2W</b>
<b>FIXTURE</b>	ADJUSTABLE DOWNLIGHT
<b>ADJUSTABILITY</b>	△ 28°
<b>LIGHT SOURCE</b>	POWER LED
<b>POWER</b>	MAX 2W
<b>SUPPLY</b>	8-32 Vdc
<b>PROTECTION</b>	FUSE - POLARITY REVERSE SPIKE FILTER
<b>DIMMABLE</b>	YES
<b>BEAM</b>	WIDE
<b>SCREEN</b>	OPAL
<b>LED COLOUR</b>	3000K CRI >90 LMN 191lm 1mt 77lx 2mt 19x 3mt 9x
<b>IP RATE</b>	IP66
<b>MATERIALS</b>	BODY: STAINLESS STEEL AISI 316 HEATSINK: SPECIAL COMPOUND
<b>MOUNTING SYSTEM</b>	WIRE SPRINGS
<b>OPTIONAL LED COLOUR</b>	2700K - 4000K - (3000K+RED)

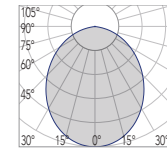

<b>CODE</b>	<b>3550-90A-B4W</b>
<b>FIXTURE</b>	ADJUSTABLE DOWNLIGHT
<b>ADJUSTABILITY</b>	△ 32°
<b>LIGHT SOURCE</b>	POWER LED
<b>POWER</b>	MAX 4W
<b>SUPPLY</b>	8-32 Vdc
<b>PROTECTION</b>	FUSE - POLARITY REVERSE SPIKE FILTER
<b>DIMMABLE</b>	YES
<b>BEAM</b>	WIDE
<b>SCREEN</b>	OPAL
<b>LED COLOUR</b>	3000K CRI >90 LMN 330lm 1mt 143lx 2mt 36lx 3mt 16lx
<b>IP RATE</b>	IP66
<b>MATERIALS</b>	BODY: STAINLESS STEEL AISI 316 HEATSINK: SPECIAL COMPOUND
<b>MOUNTING SYSTEM</b>	WIRE SPRINGS
<b>OPTIONAL LED COLOUR</b>	2700K - 4000K - (3000K+RED)

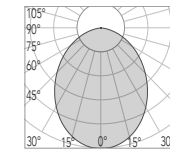

NEW UNSCREWABLE FLANGE ENABLING EASY REPLACEMENT AND CHANGE OF APPEARANCE



atlanta r - 80, 90

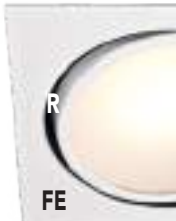

**FINISHES**

**R=FE**

23

20

4

34



# charlotte

. 55

. 70

. 80

. 90

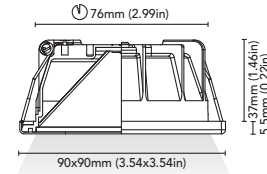
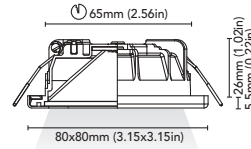
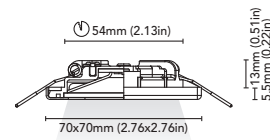
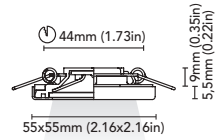

CODE	<b>3407-55A-B1.5W</b> <b>3407-55C-B1.5W</b>
FIXTURE	FIXED DOWNLIGHT
ADJUSTABILITY	NO
LIGHT SOURCE	POWER LED
POWER	MAX 1,5W
SUPPLY	8-32 Vdc
PROTECTION	FUSE - POLARITY REVERSE SPIKE FILTER
DIMMABLE	YES
BEAM	WIDE
SCREEN	OPAL
LED COLOUR	3000K CRI >90 LMN 109lm 1mt 46lx 2mt 12lx 3mt 5lx
IP RATE	IP66
MATERIALS	BODY: STAINLESS STEEL AISI 316 HEATSINK: SPECIAL COMPOUND
MOUNTING SYSTEM	(A) WIRE SPRINGS (C) SCREWS
OPTIONAL SWITCH ON THE FRAME	
LED COLOUR	2700K - 4000K - RED - BLUE

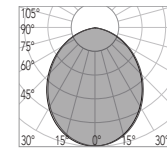

CODE	<b>3407-70A-B2W</b> <b>3407-70C-B2W</b>
FIXTURE	FIXED DOWNLIGHT
ADJUSTABILITY	NO
LIGHT SOURCE	POWER LED
POWER	MAX 2W
SUPPLY	8-32 Vdc
PROTECTION	FUSE - POLARITY REVERSE SPIKE FILTER
DIMMABLE	YES
BEAM	WIDE
SCREEN	OPAL
LED COLOUR	3000K CRI >90 LMN 191lm 1mt 77lx 2mt 19lx 3mt 9lx
IP RATE	IP66
MATERIALS	BODY: STAINLESS STEEL AISI 316 HEATSINK: SPECIAL COMPOUND
MOUNTING SYSTEM	(A) WIRE SPRINGS (C) SCREWS
OPTIONAL SWITCH ON THE FRAME	AVAILABLE
LED COLOUR	2700K - 4000K - (3000K+RED)

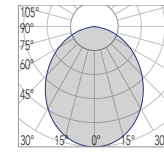

CODE	<b>3407-80A-B4W</b> <b>3407-80C-B4W</b>
FIXTURE	FIXED DOWNLIGHT
ADJUSTABILITY	NO
LIGHT SOURCE	POWER LED
POWER	MAX 4W
SUPPLY	8-32 Vdc
PROTECTION	FUSE - POLARITY REVERSE SPIKE FILTER
DIMMABLE	YES
BEAM	WIDE
SCREEN	OPAL
LED COLOUR	3000K CRI >90 LMN 330lm 1mt 143lx 2mt 36lx 3mt 16lx
IP RATE	IP66
MATERIALS	BODY: STAINLESS STEEL AISI 316 HEATSINK: SPECIAL COMPOUND
MOUNTING SYSTEM	(A) WIRE SPRINGS (C) SCREWS
OPTIONAL SWITCH ON THE FRAME	AVAILABLE
LED COLOUR	2700K - 4000K - (3000K+RED)

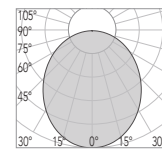

CODE	<b>3407-90A-B6W</b> <b>3407-90C-B6W</b>
FIXTURE	FIXED DOWNLIGHT
ADJUSTABILITY	NO
LIGHT SOURCE	POWER LED
POWER	MAX 6W
SUPPLY	8-32 Vdc
PROTECTION	FUSE - POLARITY REVERSE SPIKE FILTER
DIMMABLE	YES
BEAM	WIDE
SCREEN	OPAL
LED COLOUR	3000K CRI >90 LMN 399lm 1mt 178lx 2mt 45lx 3mt 20lx
IP RATE	IP66
MATERIALS	BODY: STAINLESS STEEL AISI 316 HEATSINK: SPECIAL COMPOUND
MOUNTING SYSTEM	(A) WIRE SPRINGS (C) SCREWS
OPTIONAL SWITCH ON THE FRAME	AVAILABLE
LED COLOUR	2700K - 4000K - (3000K+RED)

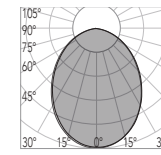

charlotte - 55, 70, 80, 90



FINISHES

**FE**

● 23

○ 20

● 4

● 34

switch on the frame





# daytona

. 80

. 90

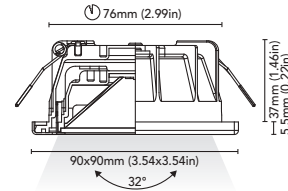
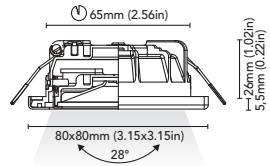

CODE	<b>3409-80A-B2W</b> <b>3409-80C-B2W</b>
FIXTURE	ADJUSTABLE DOWNLIGHT
ADJUSTABILITY	△ 28°
LIGHT SOURCE	POWER LED
POWER	MAX 2W
SUPPLY	8-32 Vdc
PROTECTION	FUSE - POLARITY REVERSE SPIKE FILTER
DIMMABLE	YES
BEAM	WIDE
SCREEN	OPAL
LED COLOUR	3000K CRI >90 LMN 191lm 1mt 77lx 2mt 19x 3mt 9x
IP RATE	IP66
MATERIALS	BODY: STAINLESS STEEL AISI 316 HEATSINK: SPECIAL COMPOUND
MOUNTING SYSTEM	(A) WIRE SPRINGS (C) SCREWS
OPTIONAL SWITCH ON THE FRAME	AVAILABLE
LED COLOUR	2700K - 4000K - (3000K+RED)

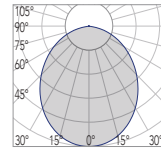

CODE	<b>3409-90A-B4W</b> <b>3409-90C-B4W</b>
FIXTURE	ADJUSTABLE DOWNLIGHT
ADJUSTABILITY	△ 32°
LIGHT SOURCE	POWER LED
POWER	MAX 4W
SUPPLY	8-32 Vdc
PROTECTION	FUSE - POLARITY REVERSE SPIKE FILTER
DIMMABLE	YES
BEAM	WIDE
SCREEN	OPAL
LED COLOUR	3000K CRI >90 LMN 330lm 1mt 143lx 2mt 36lx 3mt 16lx
IP RATE	IP66
MATERIALS	BODY: STAINLESS STEEL AISI 316 HEATSINK: SPECIAL COMPOUND
MOUNTING SYSTEM	(A) WIRE SPRINGS (C) SCREWS
OPTIONAL SWITCH ON THE FRAME	AVAILABLE
LED COLOUR	2700K - 4000K - (3000K+RED)

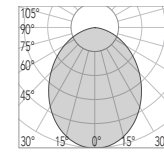

daytona - 80, 90



FINISHES **FE=R**

23 20 4 34



switch on the frame





# venice

. 55

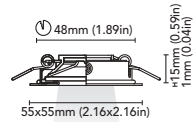

. 70

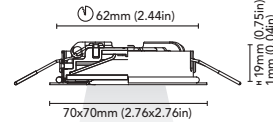

. 80

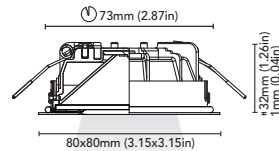

. 90

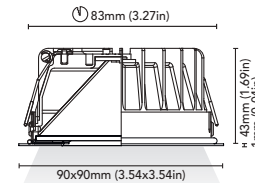

CODE	<b>3411-55A-B1.5W</b>
FIXTURE	FIXED DOWNLIGHT
ADJUSTABILITY	NO
LIGHT SOURCE	POWER LED
POWER	MAX 1,5W
SUPPLY	8-32 Vdc
PROTECTION	FUSE - POLARITY REVERSE SPIKE FILTER
DIMMABLE	YES
BEAM	WIDE
SCREEN	OPAL
LED COLOUR	3000K CRI >90 LMN 91lm 1mt 40lx 2mt 10lx 3mt 4lx
IP RATE	IP66
MATERIALS	BODY: STAINLESS STEEL AISI 316 HEATSINK: SPECIAL COMPOUND
MOUNTING SYSTEM	WIRE SPRINGS
OPTIONAL	
LED COLOUR	2700K - 4000K - RED - BLUE

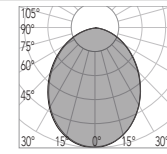

CODE	<b>3411-70A-B2W</b>
FIXTURE	FIXED DOWNLIGHT
ADJUSTABILITY	NO
LIGHT SOURCE	POWER LED
POWER	MAX 2W
SUPPLY	8-32 Vdc
PROTECTION	FUSE - POLARITY REVERSE SPIKE FILTER
DIMMABLE	YES
BEAM	WIDE
SCREEN	OPAL
LED COLOUR	3000K CRI >90 LMN 173lm 1mt 75lx 2mt 19lx 3mt 8lx
IP RATE	IP66
MATERIALS	BODY: STAINLESS STEEL AISI 316 HEATSINK: SPECIAL COMPOUND
MOUNTING SYSTEM	WIRE SPRINGS
OPTIONAL	
LED COLOUR	2700K - 4000K - (3000K+RED)

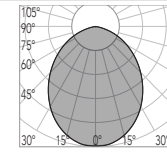

CODE	<b>3411-80A-B4W</b>
FIXTURE	FIXED DOWNLIGHT
ADJUSTABILITY	NO
LIGHT SOURCE	POWER LED
POWER	MAX 4W
SUPPLY	8-32 Vdc
PROTECTION	FUSE - POLARITY REVERSE SPIKE FILTER
DIMMABLE	YES
BEAM	WIDE
SCREEN	OPAL
LED COLOUR	3000K CRI >90 LMN 269lm 1mt 117lx 2mt 29lx 3mt 13lx
IP RATE	IP66
MATERIALS	BODY: STAINLESS STEEL AISI 316 HEATSINK: SPECIAL COMPOUND
MOUNTING SYSTEM	WIRE SPRINGS
OPTIONAL	
LED COLOUR	2700K - 4000K - (3000K+RED)

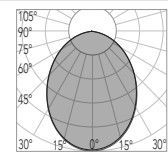

CODE	<b>3411-90A-B6W</b>
FIXTURE	FIXED DOWNLIGHT
ADJUSTABILITY	NO
LIGHT SOURCE	POWER LED
POWER	MAX 6W
SUPPLY	8-32 Vdc
PROTECTION	FUSE - POLARITY REVERSE SPIKE FILTER
DIMMABLE	YES
BEAM	WIDE
SCREEN	OPAL
LED COLOUR	3000K CRI >90 LMN 305lm 1mt 147lx 2mt 37lx 3mt 16lx
IP RATE	IP66
MATERIALS	BODY: STAINLESS STEEL AISI 316 HEATSINK: SPECIAL COMPOUND
MOUNTING SYSTEM	WIRE SPRINGS
OPTIONAL	
LED COLOUR	2700K - 4000K - (3000K+RED)

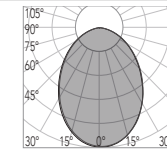

venice - 55, 70, 80, 90



FINISHES

**FE**

23  
●

20  
○

4  
●

34  
●



# venice r

. 55

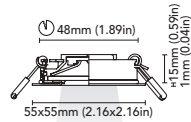

. 70

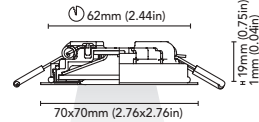

. 80

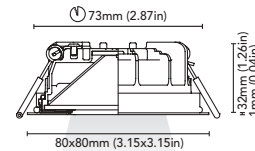

. 90

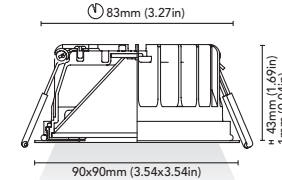

NEW UNSCREWABLE  
FLANGE ENABLING  
EASY REPLACEMENT  
AND CHANGE  
OF APPEARANCE

CODE	<b>3548-55A-B1.5W</b>
FIXTURE	FIXED DOWNLIGHT
ADJUSTABILITY	NO
LIGHT SOURCE	POWER LED
POWER	MAX 1,5W
SUPPLY	8-32 Vdc
PROTECTION	FUSE - POLARITY REVERSE SPIKE FILTER
DIMMABLE	YES
BEAM	WIDE
SCREEN	OPAL
LED COLOUR	3000K CRI >90 LMN 91lm 1mt 40lx 2mt 10lx 3mt 4lx
IP RATE	IP66
MATERIALS	BODY: STAINLESS STEEL AISI 316 HEATSINK: SPECIAL COMPOUND
MOUNTING SYSTEM	WIRE SPRINGS
OPTIONAL	
LED COLOUR	2700K - 4000K - RED - BLUE

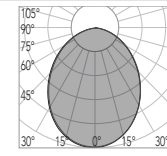

CODE	<b>3548-70A-B2W</b>
FIXTURE	FIXED DOWNLIGHT
ADJUSTABILITY	NO
LIGHT SOURCE	POWER LED
POWER	MAX 2W
SUPPLY	8-32 Vdc
PROTECTION	FUSE - POLARITY REVERSE SPIKE FILTER
DIMMABLE	YES
BEAM	WIDE
SCREEN	OPAL
LED COLOUR	3000K CRI >90 LMN 173lm 1mt 75lx 2mt 19lx 3mt 8lx
IP RATE	IP66
MATERIALS	BODY: STAINLESS STEEL AISI 316 HEATSINK: SPECIAL COMPOUND
MOUNTING SYSTEM	WIRE SPRINGS
OPTIONAL	
LED COLOUR	2700K - 4000K - (3000K+RED)

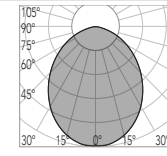

CODE	<b>3548-80A-B4W</b>
FIXTURE	FIXED DOWNLIGHT
ADJUSTABILITY	NO
LIGHT SOURCE	POWER LED
POWER	MAX 4W
SUPPLY	8-32 Vdc
PROTECTION	FUSE - POLARITY REVERSE SPIKE FILTER
DIMMABLE	YES
BEAM	WIDE
SCREEN	OPAL
LED COLOUR	3000K CRI >90 LMN 269lm 1mt 117lx 2mt 29lx 3mt 13lx
IP RATE	IP66
MATERIALS	BODY: STAINLESS STEEL AISI 316 HEATSINK: SPECIAL COMPOUND
MOUNTING SYSTEM	WIRE SPRINGS
OPTIONAL	
LED COLOUR	2700K - 4000K - (3000K+RED)

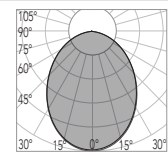

CODE	<b>3548-90A-B6W</b>
FIXTURE	FIXED DOWNLIGHT
ADJUSTABILITY	NO
LIGHT SOURCE	POWER LED
POWER	MAX 6W
SUPPLY	8-32 Vdc
PROTECTION	FUSE - POLARITY REVERSE SPIKE FILTER
DIMMABLE	YES
BEAM	WIDE
SCREEN	OPAL
LED COLOUR	3000K CRI >90 LMN 305lm 1mt 147lx 2mt 37lx 3mt 16lx
IP RATE	IP66
MATERIALS	BODY: STAINLESS STEEL AISI 316 HEATSINK: SPECIAL COMPOUND
MOUNTING SYSTEM	WIRE SPRINGS
OPTIONAL	
LED COLOUR	2700K - 4000K - (3000K+RED)

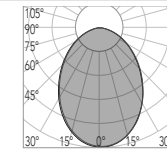

venice r - 55, 70, 80, 90



FINISHES

**FE**

23  
●

20  
○

4  
●

34  
●



# miami

. 55

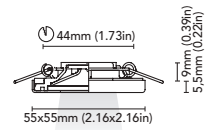

. 70

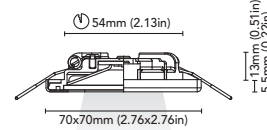

. 80

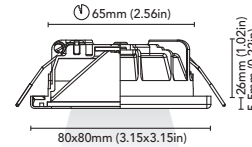

. 90

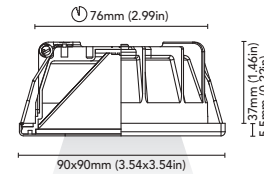

CODE	<b>3405-55A-B1.5W</b> <b>3405-55C-B1.5W</b>
FIXTURE	FIXED DOWNLIGHT
ADJUSTABILITY	NO
LIGHT SOURCE	POWER LED
POWER	MAX 1,5W
SUPPLY	8-32 Vdc
PROTECTION	FUSE - POLARITY REVERSE SPIKE FILTER
DIMMABLE	YES
BEAM	WIDE
SCREEN	OPAL
LED COLOUR	3000K CRI >90 LMN 91lm 1mt 40lx 2mt 10lx 3mt 4lx
IP RATE	IP66
MATERIALS	BODY: STAINLESS STEEL AISI 316 HEATSINK: SPECIAL COMPOUND
MOUNTING SYSTEM	(A) WIRE SPRINGS (C) SCREWS
OPTIONAL SWITCH ON THE FRAME	
LED COLOUR	2700K - 4000K - (3000K+RED)

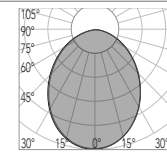

CODE	<b>3405-70A-B2W</b> <b>3405-70C-B2W</b>
FIXTURE	FIXED DOWNLIGHT
ADJUSTABILITY	NO
LIGHT SOURCE	POWER LED
POWER	MAX 2W
SUPPLY	8-32 Vdc
PROTECTION	FUSE - POLARITY REVERSE SPIKE FILTER
DIMMABLE	YES
BEAM	WIDE
SCREEN	OPAL
LED COLOUR	3000K CRI >90 LMN 173lm 1mt 75lx 2mt 19lx 3mt 8lx
IP RATE	IP66
MATERIALS	BODY: STAINLESS STEEL AISI 316 HEATSINK: SPECIAL COMPOUND
MOUNTING SYSTEM	(A) WIRE SPRINGS (C) SCREWS
OPTIONAL SWITCH ON THE FRAME	AVAILABLE
LED COLOUR	2700K - 4000K - (3000K+RED)

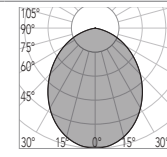

CODE	<b>3405-80A-B4W</b> <b>3405-80C-B4W</b>
FIXTURE	FIXED DOWNLIGHT
ADJUSTABILITY	NO
LIGHT SOURCE	POWER LED
POWER	MAX 4W
SUPPLY	8-32 Vdc
PROTECTION	FUSE - POLARITY REVERSE SPIKE FILTER
DIMMABLE	YES
BEAM	WIDE
SCREEN	OPAL
LED COLOUR	3000K CRI >90 LMN 269lm 1mt 117lx 2mt 29lx 3mt 13lx
IP RATE	IP66
MATERIALS	BODY: STAINLESS STEEL AISI 316 HEATSINK: SPECIAL COMPOUND
MOUNTING SYSTEM	(A) WIRE SPRINGS (C) SCREWS
OPTIONAL SWITCH ON THE FRAME	AVAILABLE
LED COLOUR	2700K - 4000K - (3000K+RED)

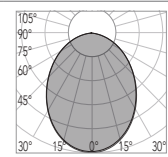

CODE	<b>3405-90A-B6W</b> <b>3405-90C-B6W</b>
FIXTURE	FIXED DOWNLIGHT
ADJUSTABILITY	NO
LIGHT SOURCE	POWER LED
POWER	MAX 6W
SUPPLY	8-32 Vdc
PROTECTION	FUSE - POLARITY REVERSE SPIKE FILTER
DIMMABLE	YES
BEAM	WIDE
SCREEN	OPAL
LED COLOUR	3000K CRI >90 LMN 305lm 1mt 147lx 2mt 37lx 3mt 16lx
IP RATE	IP66
MATERIALS	BODY: STAINLESS STEEL AISI 316 HEATSINK: SPECIAL COMPOUND
MOUNTING SYSTEM	(A) WIRE SPRINGS (C) SCREWS
OPTIONAL SWITCH ON THE FRAME	AVAILABLE
LED COLOUR	2700K - 4000K - (3000K+RED)

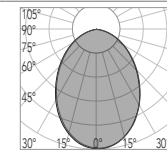

miami - 55, 70, 80, 90

FINISHES **FE**

23 20 4 34

switch on the frame





# colorado

. 77

. 87

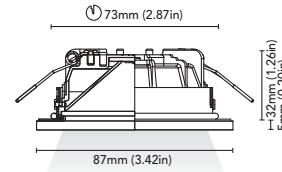
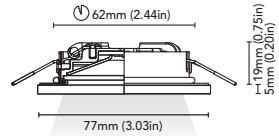

<b>CODE</b>	<b>3419-77A-B2W</b> <b>3419-77AS-B2W</b>												
<b>FIXTURE</b>	FIXED DOWNLIGHT												
<b>ADJUSTABILITY</b>	NO												
<b>LIGHT SOURCE</b>	POWER LED												
<b>POWER</b>	MAX 2W												
<b>SUPPLY</b>	8-32 Vdc												
<b>PROTECTION</b>	FUSE - POLARITY REVERSE SPIKE FILTER												
<b>DIMMABLE</b>	YES												
<b>BEAM</b>	WIDE												
<b>SCREEN</b>	(A) POLISHED (AS) FROSTED												
<b>LED COLOUR</b>	<table border="1"> <tr> <td>3000K</td> <td>CRI &gt;90</td> <td rowspan="4"></td> </tr> <tr> <td>LMN</td> <td>191lm</td> </tr> <tr> <td>1mt</td> <td>77lx</td> </tr> <tr> <td>2mt</td> <td>19x</td> </tr> <tr> <td>3mt</td> <td>9x</td> <td></td> </tr> </table>	3000K	CRI >90		LMN	191lm	1mt	77lx	2mt	19x	3mt	9x	
3000K	CRI >90												
LMN	191lm												
1mt	77lx												
2mt	19x												
3mt	9x												
<b>IP RATE</b>	IP66												
<b>MATERIALS</b>	BODY: STAINLESS STEEL AISI 316 HEATSINK: SPECIAL COMPOUND												
<b>MOUNTING SYSTEM</b>	WIRE SPRINGS												
<b>OPTIONAL</b>													
<b>LED COLOUR</b>	2700K - 4000K - (3000K+RED)												

<b>CODE</b>	<b>3419-87A-B4W</b> <b>3419-87AS-B4W</b>												
<b>FIXTURE</b>	FIXED DOWNLIGHT												
<b>ADJUSTABILITY</b>	NO												
<b>LIGHT SOURCE</b>	POWER LED												
<b>POWER</b>	MAX 4W												
<b>SUPPLY</b>	8-32 Vdc												
<b>PROTECTION</b>	FUSE - POLARITY REVERSE SPIKE FILTER												
<b>DIMMABLE</b>	YES												
<b>BEAM</b>	WIDE												
<b>SCREEN</b>	(A) POLISHED (AS) FROSTED												
<b>LED COLOUR</b>	<table border="1"> <tr> <td>3000K</td> <td>CRI &gt;90</td> <td rowspan="4"></td> </tr> <tr> <td>LMN</td> <td>330lm</td> </tr> <tr> <td>1mt</td> <td>143lx</td> </tr> <tr> <td>2mt</td> <td>36lx</td> </tr> <tr> <td>3mt</td> <td>16lx</td> <td></td> </tr> </table>	3000K	CRI >90		LMN	330lm	1mt	143lx	2mt	36lx	3mt	16lx	
3000K	CRI >90												
LMN	330lm												
1mt	143lx												
2mt	36lx												
3mt	16lx												
<b>IP RATE</b>	IP66												
<b>MATERIALS</b>	BODY: STAINLESS STEEL AISI 316 HEATSINK: SPECIAL COMPOUND												
<b>MOUNTING SYSTEM</b>	WIRE SPRINGS												
<b>OPTIONAL</b>													
<b>LED COLOUR</b>	2700K - 4000K - (3000K+RED)												



colorado - 77, 87



colorado - 77S, 87S

	<b>FINISHES</b>	<b>FE</b>	20
--	-----------------	-----------	----



# aspen

. 77

. 87

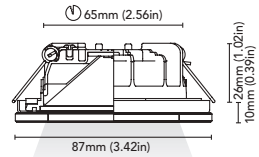
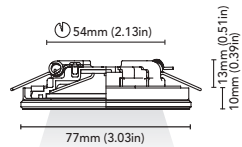

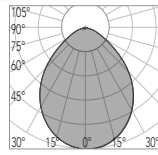
<b>CODE</b>	<b>3418-77A-B2W</b> <b>3418-77AS-B2W</b> <b>3418-77C-B2W</b> <b>3418-77CS-B2W</b>
<b>FIXTURE</b>	FIXED DOWNLIGHT
<b>ADJUSTABILITY</b>	NO
<b>LIGHT SOURCE</b>	POWER LED
<b>POWER</b>	MAX 2W
<b>SUPPLY</b>	8-32 Vdc
<b>PROTECTION</b>	FUSE - POLARITY REVERSE SPIKE FILTER
<b>DIMMABLE</b>	YES
<b>BEAM</b>	WIDE
<b>SCREEN</b>	(A,C) POLISHED (AS,CS) FROSTED
<b>LED COLOUR</b>	3000K CRI >90 LMN 191lm 1mt 77lx 2mt 19x 3mt 9x 
<b>IP RATE</b>	IP66
<b>MATERIALS</b>	BODY: STAINLESS STEEL AISI 316 HEATSINK: SPECIAL COMPOUND
<b>MOUNTING SYSTEM</b>	(A) WIRE SPRINGS (C) SCREWS
<b>OPTIONAL</b>	
<b>LED COLOUR</b>	2700K - 4000K - (3000K+RED)

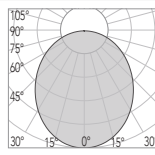
<b>CODE</b>	<b>3418-87A-B4W</b> <b>3418-87AS-B4W</b> <b>3418-87C-B4W</b> <b>3418-87CS-B4W</b>
<b>FIXTURE</b>	FIXED DOWNLIGHT
<b>ADJUSTABILITY</b>	NO
<b>LIGHT SOURCE</b>	POWER LED
<b>POWER</b>	MAX 4W
<b>SUPPLY</b>	8-32 Vdc
<b>PROTECTION</b>	FUSE - POLARITY REVERSE SPIKE FILTER
<b>DIMMABLE</b>	YES
<b>BEAM</b>	WIDE
<b>SCREEN</b>	(A,C) POLISHED (AS,CS) FROSTED
<b>LED COLOUR</b>	3000K CRI >90 LMN 330lm 1mt 143lx 2mt 36lx 3mt 16lx 
<b>IP RATE</b>	IP66
<b>MATERIALS</b>	BODY: STAINLESS STEEL AISI 316 HEATSINK: SPECIAL COMPOUND
<b>MOUNTING SYSTEM</b>	(A) WIRE SPRINGS (C) SCREWS
<b>OPTIONAL</b>	
<b>LED COLOUR</b>	2700K - 4000K - (3000K+RED)



aspen - 77, 87

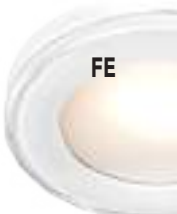

aspen - 77S, 87S

	<b>FINISHES</b>	<b>FE</b>	20
--	-----------------	-----------	----



# alabama

. 60

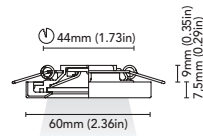

. 75

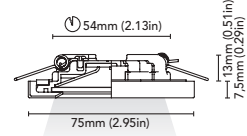

. 85

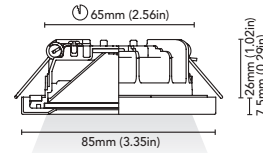

. 95

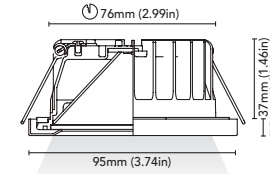

CODE	<b>3422-60A-B1.5W</b> <b>3422-60C-B1.5W</b>
FIXTURE	FIXED DOWNLIGHT
ADJUSTABILITY	NO
LIGHT SOURCE	POWER LED
POWER	MAX 1,5W
SUPPLY	8-32 Vdc
PROTECTION	FUSE - POLARITY REVERSE SPIKE FILTER
DIMMABLE	YES
BEAM	WIDE
SCREEN	OPAL
LED COLOUR	3000K CRI >90 LMN 109lm 1mt 46lx 2mt 12lx 3mt 5lx
IP RATE	IP66
MATERIALS	BODY: STAINLESS STEEL AISI 316 HEATSINK: SPECIAL COMPOUND
MOUNTING SYSTEM	(A) WIRE SPRINGS (C) SCREWS
OPTIONAL	
LED COLOUR	2700K - 4000K - RED - BLUE

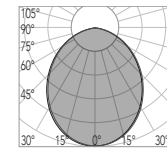

CODE	<b>3422-75A-B2W</b> <b>3422-75C-B2W</b>
FIXTURE	FIXED DOWNLIGHT
ADJUSTABILITY	NO
LIGHT SOURCE	POWER LED
POWER	MAX 2W
SUPPLY	8-32 Vdc
PROTECTION	FUSE - POLARITY REVERSE SPIKE FILTER
DIMMABLE	YES
BEAM	WIDE
SCREEN	OPAL
LED COLOUR	3000K CRI >90 LMN 191lm 1mt 77lx 2mt 19x 3mt 9x
IP RATE	IP66
MATERIALS	BODY: STAINLESS STEEL AISI 316 HEATSINK: SPECIAL COMPOUND
MOUNTING SYSTEM	(A) WIRE SPRINGS (C) SCREWS
OPTIONAL	
LED COLOUR	2700K - 4000K - (3000K+RED)

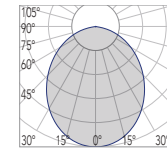

CODE	<b>3422-85A-B4W</b> <b>3422-85C-B4W</b>
FIXTURE	FIXED DOWNLIGHT
ADJUSTABILITY	NO
LIGHT SOURCE	POWER LED
POWER	MAX 4W
SUPPLY	8-32 Vdc
PROTECTION	FUSE - POLARITY REVERSE SPIKE FILTER
DIMMABLE	YES
BEAM	WIDE
SCREEN	OPAL
LED COLOUR	3000K CRI >90 LMN 330lm 1mt 143lx 2mt 36lx 3mt 16lx
IP RATE	IP66
MATERIALS	BODY: STAINLESS STEEL AISI 316 HEATSINK: SPECIAL COMPOUND
MOUNTING SYSTEM	(A) WIRE SPRINGS (C) SCREWS
OPTIONAL	
LED COLOUR	2700K - 4000K - (3000K+RED)

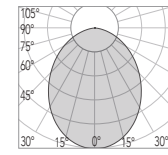

CODE	<b>3422-95A-B6W</b> <b>3422-95C-B6W</b>
FIXTURE	FIXED DOWNLIGHT
ADJUSTABILITY	NO
LIGHT SOURCE	POWER LED
POWER	MAX 6W
SUPPLY	8-32 Vdc
PROTECTION	FUSE - POLARITY REVERSE SPIKE FILTER
DIMMABLE	YES
BEAM	WIDE
SCREEN	OPAL
LED COLOUR	3000K CRI >90 LMN 399lm 1mt 178lx 2mt 45lx 3mt 20lx
IP RATE	IP66
MATERIALS	BODY: STAINLESS STEEL AISI 316 HEATSINK: SPECIAL COMPOUND
MOUNTING SYSTEM	(A) WIRE SPRINGS (C) SCREWS
OPTIONAL	
LED COLOUR	2700K - 4000K - (3000K+RED)

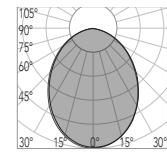

alabama - 60, 75, 85, 95



FINISHES

**FE**

23 20 4 34





Courtesy of Fairline Yachts Ltd  
Custom version with logo,  
on request



Gamma di prodotti ideati per segnapasso, luci di cortesia, etc.  
La collezione include anche piccoli "gioielli" per creare innumerevoli effetti luminosi.

*Range of products designed for path markers, courtesy lights, etc.  
The collection also includes small "jewels" to create many lighting effects.*



# dallas

## 1L . 40

## 2L . 40

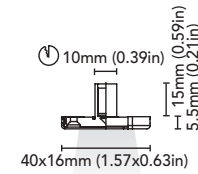
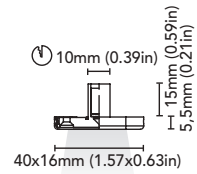

<b>CODE</b>	<b>3477-40U-1LED</b>
<b>FIXTURE</b>	FIXED COURTESY LIGHT
<b>ADJUSTABILITY</b>	NO
<b>LIGHT SOURCE</b>	LED
<b>POWER</b>	MAX 0,5W
<b>SUPPLY</b>	8-32 Vdc
<b>PROTECTION</b>	FUSE - POLARITY REVERSE SPIKE FILTER
<b>DIMMABLE</b>	YES
<b>BEAM</b>	WIDE
<b>SCREEN</b>	OPAL
<b>LED COLOUR</b>	3000K CRI >90 LMN 4lm 1mt 1lx 2mt 0lx 3mt 0lx
<b>IP RATE</b>	IP66
<b>MATERIALS</b>	STAINLESS STEEL AISI 316 AND POLYCARBONATE
<b>MOUNTING SYSTEM</b>	SCREWS
<b>OPTIONAL</b>	
<b>LED COLOUR</b>	2700K - 4000K - BLUE - RED - RGB

<b>CODE</b>	<b>3477-40G-1LED</b>
<b>FIXTURE</b>	FIXED COURTESY LIGHT
<b>ADJUSTABILITY</b>	NO
<b>LIGHT SOURCE</b>	LED
<b>POWER</b>	MAX 0,5W
<b>SUPPLY</b>	8-32 Vdc
<b>PROTECTION</b>	FUSE - POLARITY REVERSE SPIKE FILTER
<b>DIMMABLE</b>	YES
<b>BEAM</b>	WIDE
<b>SCREEN</b>	OPAL
<b>LED COLOUR</b>	3000K CRI >90 LMN 7lm 1mt 1lx 2mt 0lx 3mt 0lx
<b>IP RATE</b>	IP66
<b>MATERIALS</b>	STAINLESS STEEL AISI 316 AND POLYCARBONATE
<b>MOUNTING SYSTEM</b>	SCREWS
<b>OPTIONAL</b>	
<b>LED COLOUR</b>	2700K - 4000K - BLUE - RED - RGB

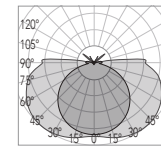
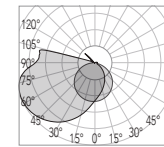

dallas 1L . 40



dallas 2L . 40

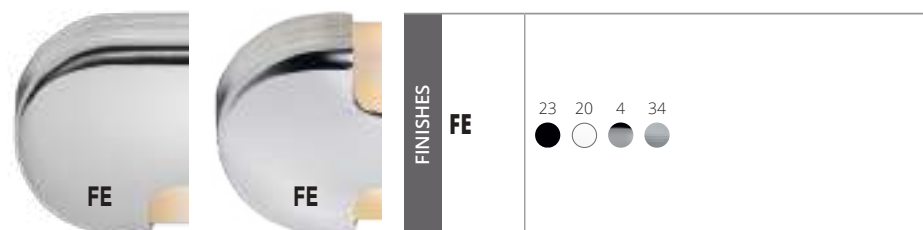



# dallas

## 1L . 80

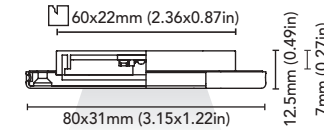
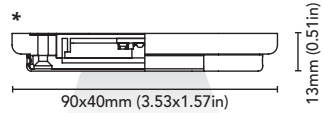

## 2L . 80

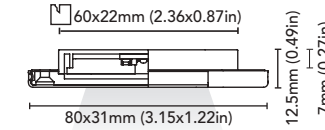
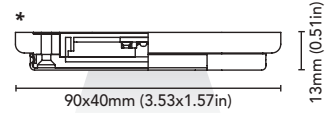

CODE	<b>3536-80U-B1.5W</b>
FIXTURE	FIXED COURTESY LIGHT
ADJUSTABILITY	NO
LIGHT SOURCE	POWER LED
POWER	MAX 1,5W
SUPPLY	8-32 Vdc
PROTECTION	FUSE - POLARITY REVERSE SPIKE FILTER
DIMMABLE	YES
BEAM	WIDE
SCREEN	OPAL
LED COLOUR	3000K CRI >90 LMN 17lm 1mt 6lx 2mt 1lx 3mt 1lx
IP RATE	IP66
MATERIALS	STAINLESS STEEL AISI 316 AND POLYCARBONATE
MOUNTING SYSTEM	SCREWS
OPTIONAL	
OPALINE SPACER	AVAILABLE
LED COLOUR	2700K - 4000K - BLUE - RED

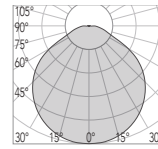

CODE	<b>3536-80G-B1.5W</b>
FIXTURE	FIXED COURTESY LIGHT
ADJUSTABILITY	NO
LIGHT SOURCE	POWER LED
POWER	MAX 1,5W
SUPPLY	8-32 Vdc
PROTECTION	FUSE - POLARITY REVERSE SPIKE FILTER
DIMMABLE	YES
BEAM	WIDE
SCREEN	OPAL
LED COLOUR	3000K CRI >90 LMN 30lm 1mt 9lx 2mt 2lx 3mt 1lx
IP RATE	IP66
MATERIALS	STAINLESS STEEL AISI 316 AND POLYCARBONATE
MOUNTING SYSTEM	SCREWS
OPTIONAL	
OPALINE SPACER	AVAILABLE
LED COLOUR	2700K - 4000K - BLUE - RED

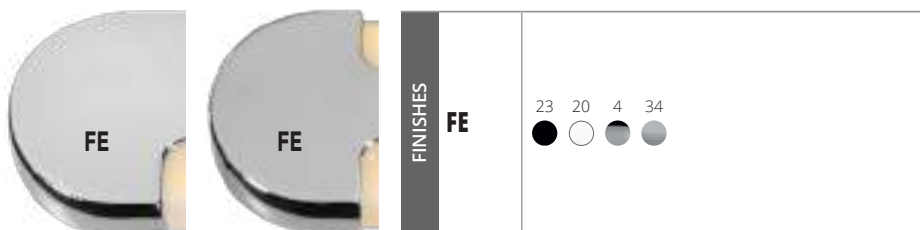
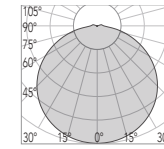

dallas 1L . 80



WITH BEHIND  
OPALINE  
SPACER

dallas 1L . 80 PLUS



dallas 2L . 80



WITH BEHIND  
OPALINE  
SPACER

dallas 2L . 80 PLUS



# bedford

• 40

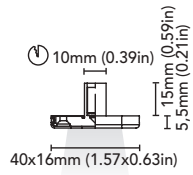

• 80

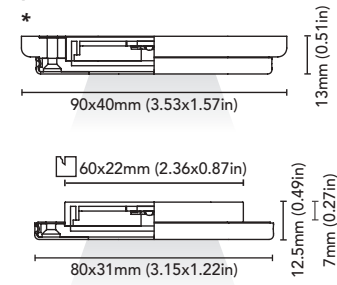

CODE	<b>3478-40-1LED</b>
FIXTURE	FIXED COURTESY LIGHT
ADJUSTABILITY	NO
LIGHT SOURCE	LED
POWER	MAX 0,5W
SUPPLY	8-32 Vdc
PROTECTION	FUSE - POLARITY REVERSE SPIKE FILTER
DIMMABLE	YES
BEAM	WIDE
SCREEN	OPAL
LED COLOUR	3000K CRI >90 LMN 10lm 1mt 3lx 2mt 1lx 3mt 0lx
IP RATE	IP66
MATERIALS	STAINLESS STEEL AISI 316 AND POLYCARBONATE
MOUNTING SYSTEM	SCREWS
OPTIONAL	
OPALINE SPACER	
LED COLOUR	2700K - 4000K - BLUE - RED - RGB

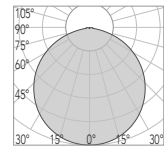

CODE	<b>3537-80-B1.5W</b>
FIXTURE	FIXED COURTESY LIGHT
ADJUSTABILITY	NO
LIGHT SOURCE	POWER LED
POWER	MAX 1,5W
SUPPLY	8-32 Vdc
PROTECTION	FUSE - POLARITY REVERSE SPIKE FILTER
DIMMABLE	YES
BEAM	WIDE
SCREEN	OPAL
LED COLOUR	3000K CRI >90 LMN 60lm 1mt 22lx 2mt 5lx 3mt 2lx
IP RATE	IP66
MATERIALS	STAINLESS STEEL AISI 316 AND POLYCARBONATE
MOUNTING SYSTEM	SCREWS
OPTIONAL	
OPALINE SPACER	AVAILABLE
LED COLOUR	2700K - 4000K - BLUE - RED

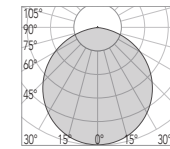

bedford . 40



bedford . 80



WITH BEHIND  
OPALINE  
SPACER

bedford . 80 PLUS

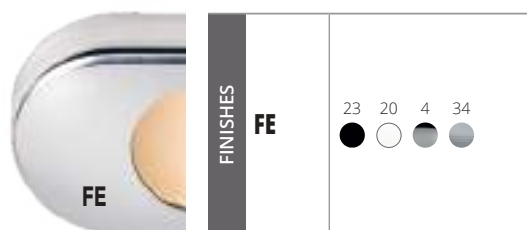



# savannah

• 40

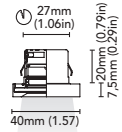

<b>CODE</b>	<b>3432-40-B1.5W</b>
<b>FIXTURE</b>	FIXED DOWNLIGHT
<b>ADJUSTABILITY</b>	NO
<b>LIGHT SOURCE</b>	POWER LED
<b>POWER</b>	MAX 1,5W
<b>SUPPLY</b>	8-32 Vdc
<b>PROTECTION</b>	FUSE - POLARITY REVERSE SPIKE FILTER
<b>DIMMABLE</b>	YES
<b>BEAM</b>	WIDE
<b>SCREEN</b>	OPAL
<b>LED COLOUR</b>	3000K CRI >90 LMN 12lm 1mt 4lx 2mt 1lx 3mt 0lx
<b>IP RATE</b>	IP66
<b>MATERIALS</b>	BODY: STAINLESS STEEL AISI 316 HEATSINK: SPECIAL COMPOUND
<b>MOUNTING SYSTEM</b>	BANDED SPRINGS OR SCREWS
<b>OPTIONAL LED COLOUR</b>	2700K - 4000K - RED - BLUE

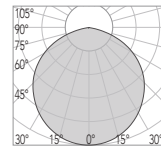

savannah

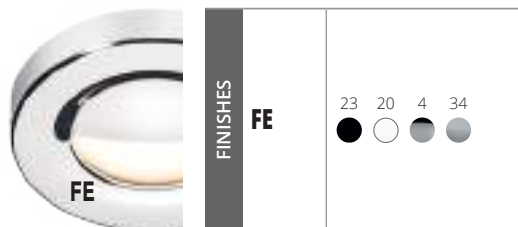



# tampa

. 40

# sarasota

. 40

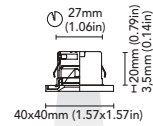
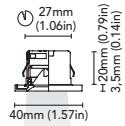

<b>CODE</b>	<b>3416-40-Z1.5W</b>
<b>FIXTURE</b>	FIXED DOWNLIGHT
<b>ADJUSTABILITY</b>	NO
<b>LIGHT SOURCE</b>	POWER LED
<b>POWER</b>	MAX 1,5W
<b>SUPPLY</b>	8-32 Vdc
<b>PROTECTION</b>	FUSE - POLARITY REVERSE SPIKE FILTER
<b>DIMMABLE</b>	YES
<b>BEAM</b>	MEDIUM
<b>SCREEN</b>	CLEAR
<b>LED COLOUR</b>	3000K CRI >90 LMN 120lm 1mt 483lx 2mt 121lx 3mt 54lx
<b>IP RATE</b>	IP66
<b>MATERIALS</b>	BODY: STAINLESS STEEL AISI 316 HEATSINK: SPECIAL COMPOUND
<b>MOUNTING SYSTEM</b>	BANDED SPRINGS OR SCREWS
<b>OPTIONAL LED COLOUR</b>	2700K - 4000K - RED - BLUE

<b>CODE</b>	<b>3417-40-Z1.5W</b>
<b>FIXTURE</b>	FIXED DOWNLIGHT
<b>ADJUSTABILITY</b>	NO
<b>LIGHT SOURCE</b>	POWER LED
<b>POWER</b>	MAX 1,5W
<b>SUPPLY</b>	8-32 Vdc
<b>PROTECTION</b>	FUSE - POLARITY REVERSE SPIKE FILTER
<b>DIMMABLE</b>	YES
<b>BEAM</b>	MEDIUM
<b>SCREEN</b>	CLEAR
<b>LED COLOUR</b>	3000K CRI >90 LMN 120lm 1mt 483lx 2mt 121lx 3mt 54lx
<b>IP RATE</b>	IP66
<b>MATERIALS</b>	BODY: STAINLESS STEEL AISI 316 HEATSINK: SPECIAL COMPOUND
<b>MOUNTING SYSTEM</b>	BANDED SPRINGS OR SCREWS
<b>OPTIONAL LED COLOUR</b>	2700K - 4000K - RED - BLUE



tampa



sarasota

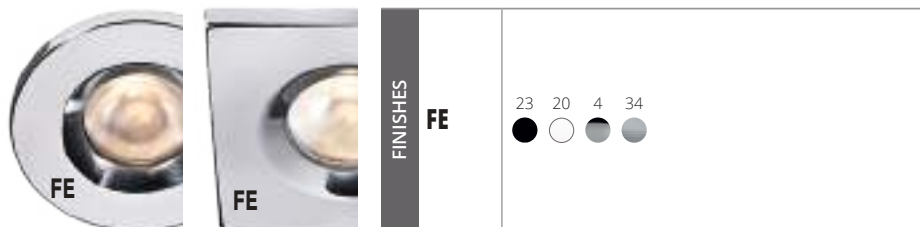



# florida

## 1L . 40

## 2L . 40

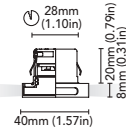
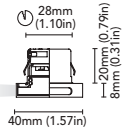

<b>CODE</b>	<b>3420-40U-B1.5W</b>
<b>FIXTURE</b>	FIXED DOWNLIGHT
<b>ADJUSTABILITY</b>	NO
<b>LIGHT SOURCE</b>	POWER LED
<b>POWER</b>	MAX 1,5W
<b>SUPPLY</b>	8-32 Vdc
<b>PROTECTION</b>	FUSE - POLARITY REVERSE SPIKE FILTER
<b>DIMMABLE</b>	YES
<b>BEAM</b>	WIDE
<b>SCREEN</b>	FROSTED
<b>LED COLOUR</b>	3000K CRI >90 LMN 1lm 1mt 0lx 2mt 0lx 3mt 0lx
<b>IP RATE</b>	IP66
<b>MATERIALS</b>	BODY: STAINLESS STEEL AISI 316 HEATSINK: SPECIAL COMPOUND
<b>MOUNTING SYSTEM</b>	BANDED SPRINGS OR SCREWS
<b>OPTIONAL LED COLOUR</b>	2700K - 4000K - RED - BLUE

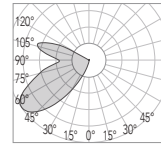

<b>CODE</b>	<b>3420-40G-B1.5W</b>
<b>FIXTURE</b>	FIXED DOWNLIGHT
<b>ADJUSTABILITY</b>	NO
<b>LIGHT SOURCE</b>	POWER LED
<b>POWER</b>	MAX 1,5W
<b>SUPPLY</b>	8-32 Vdc
<b>PROTECTION</b>	FUSE - POLARITY REVERSE SPIKE FILTER
<b>DIMMABLE</b>	YES
<b>BEAM</b>	WIDE
<b>SCREEN</b>	FROSTED
<b>LED COLOUR</b>	3000K CRI >90 LMN 2lm 1mt 0lx 2mt 0lx 3mt 0lx
<b>IP RATE</b>	IP66
<b>MATERIALS</b>	BODY: STAINLESS STEEL AISI 316 HEATSINK: SPECIAL COMPOUND
<b>MOUNTING SYSTEM</b>	BANDED SPRINGS OR SCREWS
<b>OPTIONAL LED COLOUR</b>	2700K - 4000K - RED - BLUE

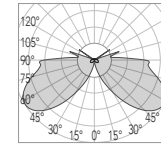

florida 1L

florida 2L



**FINISHES**

**FE**

23

20

4

34



# portland

## 1L . 40

## 2L . 40

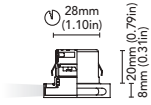

40x40mm (1.57x1.57in)

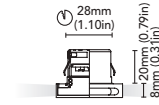

40x40mm (1.57x1.57in)

<b>CODE</b>	<b>3421-40U-B1.5W</b>
<b>FIXTURE</b>	FIXED DOWNLIGHT
<b>ADJUSTABILITY</b>	NO
<b>LIGHT SOURCE</b>	POWER LED
<b>POWER</b>	MAX 1,5W
<b>SUPPLY</b>	8-32 Vdc
<b>PROTECTION</b>	FUSE - POLARITY REVERSE SPIKE FILTER
<b>DIMMABLE</b>	YES
<b>BEAM</b>	WIDE
<b>SCREEN</b>	FROSTED
<b>LED COLOUR</b>	3000K CRI >90 LMN 1lm 1mt 0lx 2mt 0lx 3mt 0lx
<b>IP RATE</b>	IP66
<b>MATERIALS</b>	BODY: STAINLESS STEEL AISI 316 HEATSINK: SPECIAL COMPOUND
<b>MOUNTING SYSTEM</b>	BANDED SPRINGS OR SCREWS
<b>OPTIONAL LED COLOUR</b>	2700K - 4000K - RED - BLUE

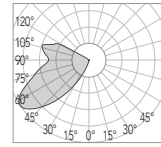

<b>CODE</b>	<b>3421-40G-B1.5W</b>
<b>FIXTURE</b>	FIXED DOWNLIGHT
<b>ADJUSTABILITY</b>	NO
<b>LIGHT SOURCE</b>	POWER LED
<b>POWER</b>	MAX 1,5W
<b>SUPPLY</b>	8-32 Vdc
<b>PROTECTION</b>	FUSE - POLARITY REVERSE SPIKE FILTER
<b>DIMMABLE</b>	YES
<b>BEAM</b>	WIDE
<b>SCREEN</b>	FROSTED
<b>LED COLOUR</b>	3000K CRI >90 LMN 2lm 1mt 0lx 2mt 0lx 3mt 0lx
<b>IP RATE</b>	IP66
<b>MATERIALS</b>	BODY: STAINLESS STEEL AISI 316 HEATSINK: SPECIAL COMPOUND
<b>MOUNTING SYSTEM</b>	BANDED SPRINGS OR SCREWS
<b>OPTIONAL LED COLOUR</b>	2700K - 4000K - RED - BLUE

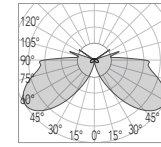

portland 1L

portland 2L

FE

FINISHES

**FE**

23 20 4 34



# columbia nevada

. 35

. 35

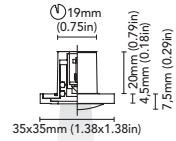
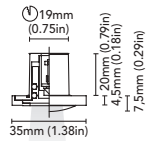

<b>CODE</b>	<b>3452-35-1LED</b>
<b>FIXTURE</b>	FIXED DOWNLIGHT
<b>ADJUSTABILITY</b>	NO
<b>LIGHT SOURCE</b>	LED
<b>POWER</b>	MAX 0,5W
<b>SUPPLY</b>	8-32 Vdc
<b>PROTECTION</b>	FUSE - POLARITY REVERSE SPIKE FILTER
<b>DIMMABLE</b>	YES
<b>BEAM</b>	WIDE
<b>SCREEN</b>	OPAL
<b>LED COLOUR</b>	3000K CRI >90 LMN 2lm 1mt 0lx 2mt 0lx 3mt 0lx
<b>IP RATE</b>	IP66
<b>MATERIALS</b>	BODY: STAINLESS STEEL AISI 316
<b>MOUNTING SYSTEM</b>	SCREWS
<b>OPTIONAL LED COLOUR</b>	2700K - 4000K - RED - BLUE - RGB

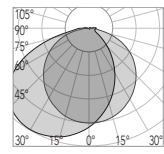

<b>CODE</b>	<b>3454-35-1LED</b>
<b>FIXTURE</b>	FIXED DOWNLIGHT
<b>ADJUSTABILITY</b>	NO
<b>LIGHT SOURCE</b>	LED
<b>POWER</b>	MAX 0,5W
<b>SUPPLY</b>	8-32 Vdc
<b>PROTECTION</b>	FUSE - POLARITY REVERSE SPIKE FILTER
<b>DIMMABLE</b>	YES
<b>BEAM</b>	WIDE
<b>SCREEN</b>	OPAL
<b>LED COLOUR</b>	3000K CRI >90 LMN 2lm 1mt 0lx 2mt 0lx 3mt 0lx
<b>IP RATE</b>	IP66
<b>MATERIALS</b>	BODY: STAINLESS STEEL AISI 316
<b>MOUNTING SYSTEM</b>	SCREWS
<b>OPTIONAL LED COLOUR</b>	2700K - 4000K - RED - BLUE - RGB

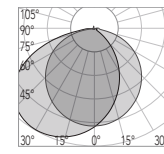

columbia



nevada





# dana

. 35

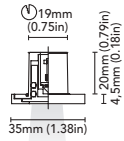

# baltimora

. 35

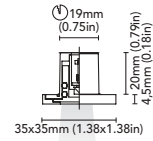

<b>CODE</b>	<b>3453-35-1LED</b>
<b>FIXTURE</b>	FIXED DOWNLIGHT
<b>ADJUSTABILITY</b>	NO
<b>LIGHT SOURCE</b>	LED
<b>POWER</b>	MAX 0,5W
<b>SUPPLY</b>	8-32 Vdc
<b>PROTECTION</b>	FUSE - POLARITY REVERSE SPIKE FILTER
<b>DIMMABLE</b>	YES
<b>BEAM</b>	WIDE
<b>SCREEN</b>	OPAL
<b>LED COLOUR</b>	3000K CRI >90 LMN 3lm 1mt 1lx 2mt 0lx 3mt 0lx
<b>IP RATE</b>	IP66
<b>MATERIALS</b>	BODY: STAINLESS STEEL AISI 316
<b>MOUNTING SYSTEM</b>	SCREWS
<b>OPTIONAL LED COLOUR</b>	2700K - 4000K - RED - BLUE - RGB

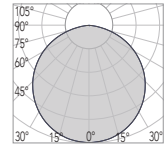

<b>CODE</b>	<b>3455-35-1LED</b>
<b>FIXTURE</b>	FIXED DOWNLIGHT
<b>ADJUSTABILITY</b>	NO
<b>LIGHT SOURCE</b>	LED
<b>POWER</b>	MAX 0,5W
<b>SUPPLY</b>	8-32 Vdc
<b>PROTECTION</b>	FUSE - POLARITY REVERSE SPIKE FILTER
<b>DIMMABLE</b>	YES
<b>BEAM</b>	WIDE
<b>SCREEN</b>	OPAL
<b>LED COLOUR</b>	3000K CRI >90 LMN 3lm 1mt 1lx 2mt 0lx 3mt 0lx
<b>IP RATE</b>	IP66
<b>MATERIALS</b>	BODY: STAINLESS STEEL AISI 316
<b>MOUNTING SYSTEM</b>	SCREWS
<b>OPTIONAL LED COLOUR</b>	2700K - 4000K - RED - BLUE - RGB

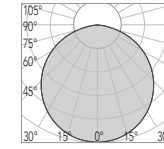

dana



baltimora

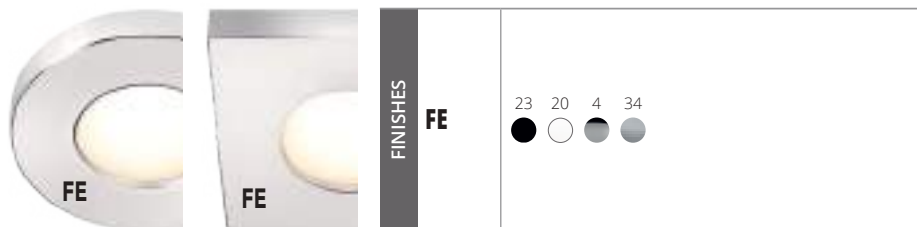



# detroit boston

. 20

. 20

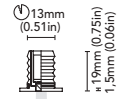

20mm (0.79in)

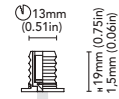

20x20mm (0.79x0.79in)

<b>CODE</b>	<b>3450-20-1LED</b>
<b>FIXTURE</b>	FIXED DOWNLIGHT
<b>ADJUSTABILITY</b>	NO
<b>LIGHT SOURCE</b>	LED
<b>POWER</b>	MAX 0,5W
<b>SUPPLY</b>	8-32 Vdc
<b>PROTECTION</b>	FUSE - POLARITY REVERSE SPIKE FILTER
<b>DIMMABLE</b>	YES
<b>BEAM</b>	WIDE
<b>SCREEN</b>	CLEAR
<b>LED COLOUR</b>	3000K CRI >90 LMN 8lm 1mt 3lx 2mt 1lx 3mt 0lx
<b>IP RATE</b>	IP66
<b>MATERIALS</b>	BODY: STAINLESS STEEL AISI 316
<b>MOUNTING SYSTEM</b>	PRESSURE BY ORING
<b>OPTIONAL LED COLOUR</b>	2700K - 4000K - RED - BLUE - RGB

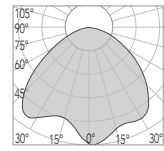

<b>CODE</b>	<b>3451-20-1LED</b>
<b>FIXTURE</b>	FIXED DOWNLIGHT
<b>ADJUSTABILITY</b>	NO
<b>LIGHT SOURCE</b>	LED
<b>POWER</b>	MAX 0,5W
<b>SUPPLY</b>	8-32 Vdc
<b>PROTECTION</b>	FUSE - POLARITY REVERSE SPIKE FILTER
<b>DIMMABLE</b>	YES
<b>BEAM</b>	WIDE
<b>SCREEN</b>	CLEAR
<b>LED COLOUR</b>	3000K CRI >90 LMN 8lm 1mt 3lx 2mt 1lx 3mt 0lx
<b>IP RATE</b>	IP66
<b>MATERIALS</b>	BODY: STAINLESS STEEL AISI 316
<b>MOUNTING SYSTEM</b>	PRESSURE BY ORING
<b>OPTIONAL LED COLOUR</b>	2700K - 4000K - RED - BLUE - RGB

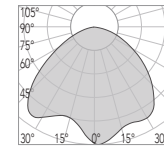

detroit



boston





# Reading Lights

Elementi luce flessibili e direzionabili, da parete o da tavolo, realizzati per la lettura o illuminazione puntuale.

*Flexible and adjustable lighting elements, for wall or table, for reading or precise illumination.*



# catalina

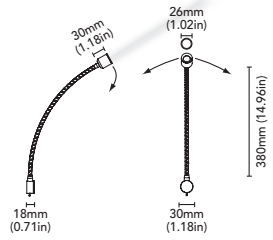

<b>CODE</b>	<b>2182-I-Z1.5W</b>
<b>FIXTURE</b>	WALL READING LIGHT
<b>ADJUSTABILITY</b>	YES
<b>LIGHT SOURCE</b>	POWER LED
<b>POWER</b>	MAX 1,5W
<b>SUPPLY</b>	8-32 Vdc
<b>PROTECTION</b>	FUSE - POLARITY REVERSE SPIKE FILTER
<b>DIMMABLE</b>	YES
<b>BEAM</b>	MEDIUM
<b>SCREEN</b>	LENS
<b>LED COLOUR</b>	3000K CRI >90 LMN 120lm 1mt 483lx 2mt 121lx 3mt 54lx
<b>IP RATE</b>	IP40
<b>MATERIALS</b>	BODY: BRASS
<b>MOUNTING SYSTEM</b>	SCREWS
<b>OPTIONAL LED COLOUR</b>	2700K - 4000K - RED

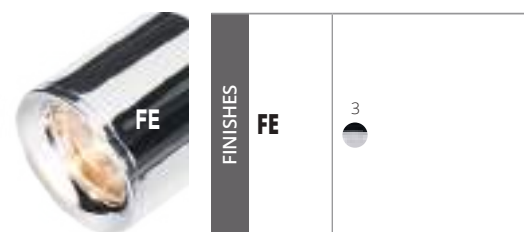
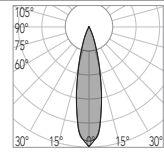

FINISHES

FE

3



catalina



# ventura

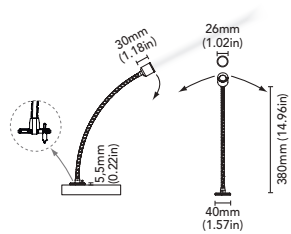

<b>CODE</b>	<b>2184-I-Z1.5W</b>
<b>FIXTURE</b>	DESK READING LIGHT
<b>ADJUSTABILITY</b>	YES
<b>LIGHT SOURCE</b>	POWER LED
<b>POWER</b>	MAX 1,5W
<b>SUPPLY</b>	8-32 Vdc
<b>PROTECTION</b>	FUSE - POLARITY REVERSE SPIKE FILTER
<b>DIMMABLE</b>	YES
<b>BEAM</b>	MEDIUM
<b>SCREEN</b>	LENS
<b>LED COLOUR</b>	3000K CRI >90 LMN 120lm 1mt 483lx 2mt 121lx 3mt 54lx
<b>IP RATE</b>	IP40
<b>MATERIALS</b>	BODY: BRASS
<b>MOUNTING SYSTEM</b>	SCREWS
<b>OPTIONAL LED COLOUR</b>	2700K - 4000K - RED

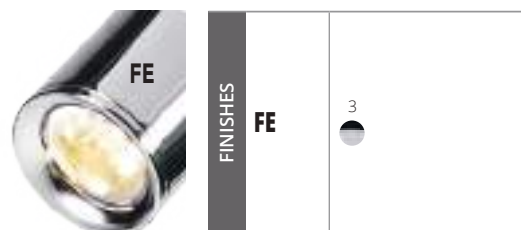
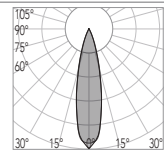

ventura



# ventura usb

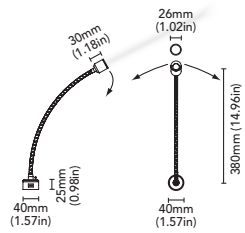

<b>CODE</b>	<b>2184U-I-Z1.5W</b>
<b>FIXTURE</b>	DESK READING LIGHT
<b>ADJUSTABILITY</b>	YES
<b>LIGHT SOURCE</b>	POWER LED
<b>POWER</b>	MAX 1,5W
<b>SUPPLY</b>	8-32 Vdc
<b>USB V OUTPUT</b>	5 Vdc
<b>USB I OUTPUT</b>	MAX 1,5A
<b>PROTECTION</b>	FUSE - POLARITY REVERSE SPIKE FILTER
<b>DIMMABLE</b>	YES
<b>BEAM</b>	MEDIUM
<b>SCREEN</b>	LENS
<b>LED COLOUR</b>	3000K CRI >90 LMN 120lm 1mt 483lx 2mt 121lx 3mt 54lx
<b>IP RATE</b>	IP40
<b>MATERIALS</b>	BODY: BRASS
<b>MOUNTING SYSTEM</b>	SCREWS
<b>OPTIONAL LED COLOUR</b>	2700K - 4000K - RED

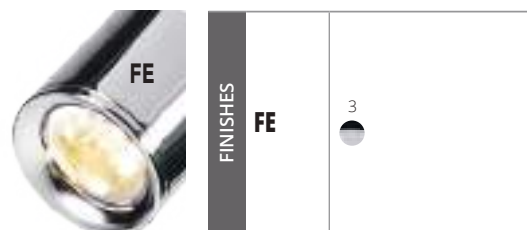
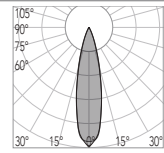

ventura usb



# arizona

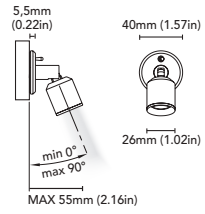

<b>CODE</b>	<b>2185-I-Z1.5W</b>
<b>FIXTURE</b>	WALL READING LIGHT
<b>ADJUSTABILITY</b>	YES
<b>LIGHT SOURCE</b>	POWER LED
<b>POWER</b>	MAX 1,5W
<b>SUPPLY</b>	8-32 Vdc
<b>PROTECTION</b>	FUSE - POLARITY REVERSE SPIKE FILTER
<b>DIMMABLE</b>	YES
<b>BEAM</b>	MEDIUM
<b>SCREEN</b>	LENS
<b>LED COLOUR</b>	3000K CRI >90 LMN 120lm 1mt 483lx 2mt 121lx 3mt 54lx
<b>IP RATE</b>	IP40
<b>MATERIALS</b>	BODY: BRASS
<b>MOUNTING SYSTEM</b>	SCREWS
<b>OPTIONAL LED COLOUR</b>	2700K - 4000K - RED

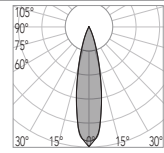

arizona

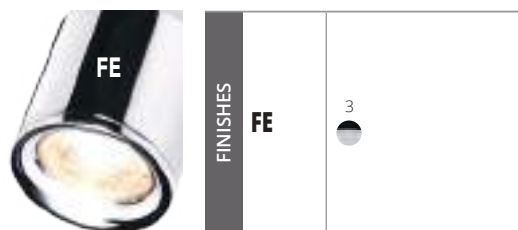



# arizona usb

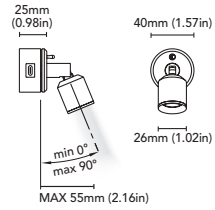

<b>CODE</b>	<b>2185U-I-Z1.5W</b>
<b>FIXTURE</b>	WALL READING LIGHT
<b>ADJUSTABILITY</b>	YES
<b>LIGHT SOURCE</b>	POWER LED
<b>POWER</b>	MAX 1,5W
<b>SUPPLY</b>	8-32 Vdc
<b>USB V OUTPUT</b>	5 Vdc
<b>USB I OUTPUT</b>	MAX 1,5A
<b>PROTECTION</b>	FUSE - POLARITY REVERSE SPIKE FILTER
<b>DIMMABLE</b>	YES
<b>BEAM</b>	MEDIUM
<b>SCREEN</b>	LENS
<b>LED COLOUR</b>	3000K CRI >90 LMN 120lm 1mt 483lx 2mt 121lx 3mt 54lx
<b>IP RATE</b>	IP40
<b>MATERIALS</b>	BODY: BRASS
<b>MOUNTING SYSTEM</b>	SCREWS
<b>OPTIONAL LED COLOUR</b>	2700K - 4000K - RED

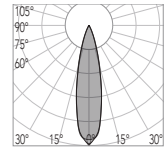

arizona usb

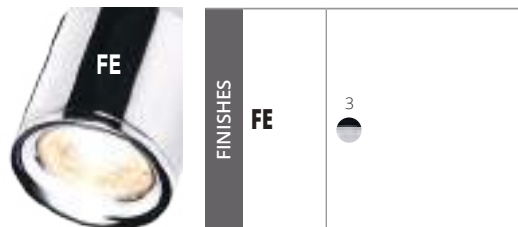



# philly

. 45

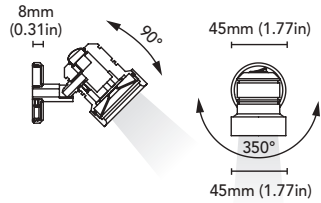

<b>CODE</b>	<b>2186-I-B3W</b>
<b>FIXTURE</b>	WALL READING LIGHT
<b>ADJUSTABILITY</b>	YES
<b>LIGHT SOURCE</b>	POWER LED
<b>POWER</b>	MAX 3W
<b>SUPPLY</b>	8-32 Vdc
<b>PROTECTION</b>	FUSE - POLARITY REVERSE SPIKE FILTER
<b>DIMMABLE</b>	YES
<b>BEAM</b>	WIDE
<b>SCREEN</b>	OPAL
<b>LED COLOUR</b>	3000K CRI >90 LMN 198lm 1mt 89lx 2mt 22lx 3mt 10lx
<b>IP RATE</b>	IP40
<b>MATERIALS</b>	BODY: ALUMINIUM
<b>MOUNTING SYSTEM</b>	SCREWS
<b>OPTIONAL LED COLOUR</b>	2700K - 4000K - RED

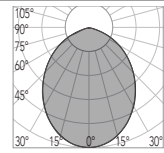

philly

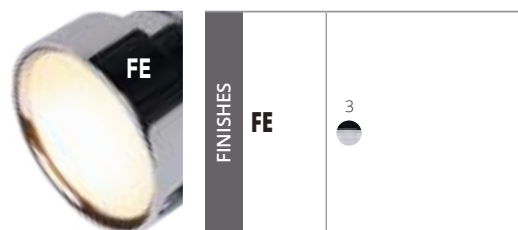



# philly usb

. 45

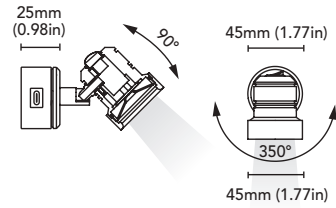

<b>CODE</b>	<b>2186U-I-B3W</b>
<b>FIXTURE</b>	WALL READING LIGHT
<b>ADJUSTABILITY</b>	YES
<b>LIGHT SOURCE</b>	POWER LED
<b>POWER</b>	MAX 3W
<b>SUPPLY</b>	8-32 Vdc
<b>USB V OUTPUT</b>	5 Vdc
<b>USB I OUTPUT</b>	MAX 1,5A
<b>PROTECTION</b>	FUSE - POLARITY REVERSE SPIKE FILTER
<b>DIMMABLE</b>	YES
<b>BEAM</b>	MEDIUM
<b>SCREEN</b>	OPAL
<b>LED COLOUR</b>	3000K CRI >90 LMN 198lm 1mt 89lx 2mt 22lx 3mt 10lx
<b>IP RATE</b>	IP40
<b>MATERIALS</b>	BODY: ALUMINIUM
<b>MOUNTING SYSTEM</b>	SCREWS
<b>OPTIONAL LED COLOUR</b>	2700K - 4000K - RED

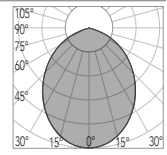

philly usb

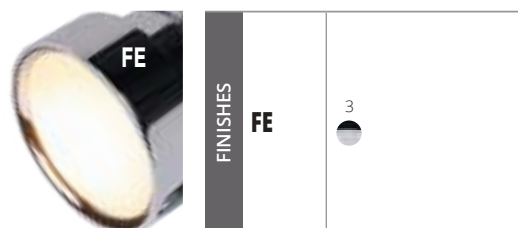



# Neonflex

Soluzione flessibile per illuminazione diffusa a LED che consente di creare disegni luminosi lineari e curvi su soffitti, pareti etc, in ambienti interni ed esterni.

Flexible solution for diffused LED lighting, it allows the creation of linear and curve lighting decorations on ceilings, walls. etc. for indoor and outdoor environment.



# ik 0606



Walkable

## • side

## • top

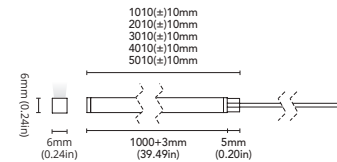
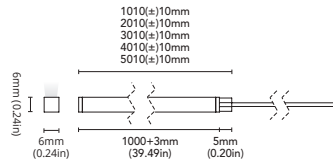

<b>CODE</b>	<b>5433-1MT-6WM</b> <b>5433-2MT-6WM</b> <b>5433-3MT-6WM</b> <b>5433-4MT-6WM</b> <b>5433-5MT-6WM</b>
<b>FIXTURE</b>	FLEXIBLE LED
<b>BENDING</b>	SIDE
<b>LIGHT SOURCE</b>	LED
<b>POWER</b>	6W/MT
<b>SUPPLY</b>	24 Vdc
<b>PROTECTION</b>	POLARITY REVERSE
<b>DIMMABLE</b>	YES
<b>BEAM</b>	WIDE
<b>SCREEN</b>	OPAL
<b>LED COLOUR</b>	3000K CRI >90 LMN 347lm/m 1mt 118lx 2mt 30lx 3mt 13lx
<b>IP RATE</b>	IP67
<b>IK RATE</b>	IK9
<b>MOUNTING SYSTEM</b>	NR. 3 CLIPS/MT
<b>MATERIALS</b>	SPECIAL SILICONE
<b>OPTIONAL</b>	
<b>LED COLOUR</b>	2700K - 4000K

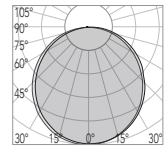

<b>CODE</b>	<b>5432-1MT-6WM</b> <b>5432-2MT-6WM</b> <b>5432-3MT-6WM</b> <b>5432-4MT-6WM</b> <b>5432-5MT-6WM</b>
<b>FIXTURE</b>	FLEXIBLE LED
<b>BENDING</b>	TOP
<b>LIGHT SOURCE</b>	LED
<b>POWER</b>	6W/MT
<b>SUPPLY</b>	24 Vdc
<b>PROTECTION</b>	POLARITY REVERSE
<b>DIMMABLE</b>	YES
<b>BEAM</b>	WIDE
<b>SCREEN</b>	OPAL
<b>LED COLOUR</b>	3000K CRI >90 LMN 483lm/m 1mt 182lx 2mt 45lx 3mt 20lx
<b>IP RATE</b>	IP67
<b>IK RATE</b>	IK10
<b>MOUNTING SYSTEM</b>	NR. 3 CLIPS/MT
<b>MATERIALS</b>	SPECIAL SILICONE
<b>OPTIONAL</b>	
<b>LED COLOUR</b>	2700K - 4000K

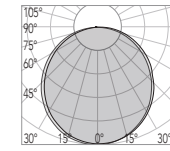



# ik 1010



Walkable

## . side

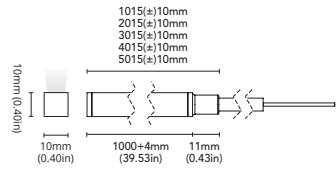

## . top

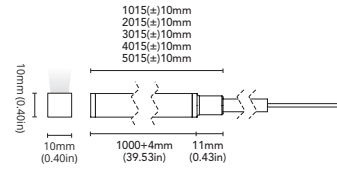

## . 3view

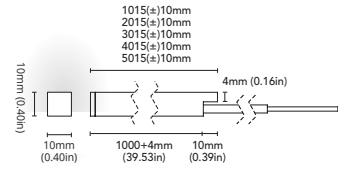

### CODE

5436-1MT-10WM  
5436-2MT-10WM  
5436-3MT-10WM  
5436-4MT-10WM  
5436-5MT-10WM

### FIXTURE

FLEXIBLE LED

### BENDING

SIDE

### LIGHT SOURCE

LED

### POWER

10W/MT

### SUPPLY

24 Vdc

### PROTECTION

POLARITY REVERSE

### DIMMABLE

YES

### BEAM

WIDE

### SCREEN

OPAL

### LED COLOUR

3000K

CRI >90

LMN 745 lm/m

1mt 256lx

2mt 64lx

3mt 28lx

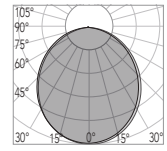

### IP RATE

IP67

### IK RATE

IK9

### MOUNTING SYSTEM

NR. 3 CLIPS/MT

### MATERIALS

SPECIAL SILICONE

### OPTIONAL

### LED COLOUR

2700K - 4000K

5435-1MT-10WM  
5435-2MT-10WM  
5435-3MT-10WM  
5435-4MT-10WM  
5435-5MT-10WM

### FIXTURE

FLEXIBLE LED

### BENDING

TOP

### LIGHT SOURCE

LED

### POWER

10W/MT

### SUPPLY

24 Vdc

### PROTECTION

POLARITY REVERSE

### DIMMABLE

YES

### BEAM

WIDE

### SCREEN

OPAL

### LED COLOUR

3000K

CRI >90

LMN 817lm/m

1mt 284lx

2mt 71lx

3mt 32lx

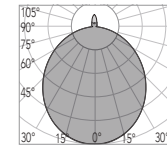

### IP RATE

IP67

### IK RATE

IK10

### MOUNTING SYSTEM

NR. 3 CLIPS/MT

### MATERIALS

SPECIAL SILICONE

### OPTIONAL

### LED COLOUR

2700K - 4000K

5434-1MT-10WM  
5434-2MT-10WM  
5434-3MT-10WM  
5434-4MT-10WM  
5434-5MT-10WM

### FIXTURE

FLEXIBLE LED

### BENDING

TOP

### LIGHT SOURCE

LED

### POWER

10W/MT

### SUPPLY

24 Vdc

### PROTECTION

POLARITY REVERSE

### DIMMABLE

YES

### BEAM

WIDE

### SCREEN

OPAL

### LED COLOUR

3000K

CRI >90

LMN 795lm/m

1mt 214lx

2mt 53lx

3mt 24lx

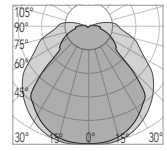

### IP RATE

IP67

### IK RATE

IK9

### MOUNTING SYSTEM

NR. 3 CLIPS/MT

### MATERIALS

SPECIAL SILICONE

### OPTIONAL

### LED COLOUR

2700K - 4000K





# ik 1617



Walkable

## . side

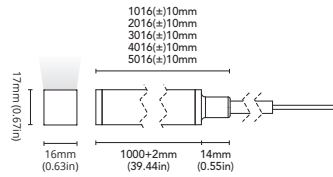

## . top

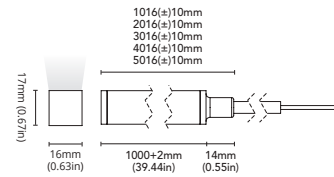

## . double bending

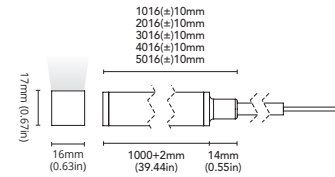

<b>CODE</b>	<b>5439-1MT-10WM</b> <b>5439-2MT-10WM</b> <b>5439-3MT-10WM</b> <b>5439-4MT-10WM</b> <b>5439-5MT-10WM</b>
<b>FIXTURE</b>	FLEXIBLE LED
<b>BENDING</b>	SIDE
<b>LIGHT SOURCE</b>	LED
<b>POWER</b>	10W/MT
<b>SUPPLY</b>	24 Vdc
<b>PROTECTION</b>	POLARITY REVERSE
<b>DIMMABLE</b>	YES
<b>BEAM</b>	WIDE
<b>SCREEN</b>	OPAL
<b>LED COLOUR</b>	3000K CRI >90 LMN 642lm/m 1mt 217lx 2mt 54lx 3mt 24lx
<b>IP RATE</b>	IP67
<b>IK RATE</b>	IK9
<b>MOUNTING SYSTEM</b>	NR. 3 CLIPS/MT
<b>MATERIALS</b>	SPECIAL SILICONE
<b>OPTIONAL</b>	
<b>LED COLOUR</b>	2700K - 4000K

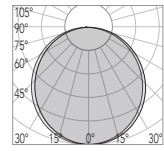

<b>CODE</b>	<b>5438-1MT-10WM</b> <b>5438-2MT-10WM</b> <b>5438-3MT-10WM</b> <b>5438-4MT-10WM</b> <b>5438-5MT-10WM</b>
<b>FIXTURE</b>	FLEXIBLE LED
<b>BENDING</b>	TOP
<b>LIGHT SOURCE</b>	LED
<b>POWER</b>	10W/MT
<b>SUPPLY</b>	24 Vdc
<b>PROTECTION</b>	POLARITY REVERSE
<b>DIMMABLE</b>	YES
<b>BEAM</b>	WIDE
<b>SCREEN</b>	OPAL
<b>LED COLOUR</b>	3000K CRI >90 LMN 889lm/m 1mt 302lx 2mt 75lx 3mt 34lx
<b>IP RATE</b>	IP67
<b>IK RATE</b>	IK10
<b>MOUNTING SYSTEM</b>	NR. 3 CLIPS/MT
<b>MATERIALS</b>	SPECIAL SILICONE
<b>OPTIONAL</b>	
<b>LED COLOUR</b>	2700K - 4000K

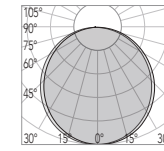

<b>CODE</b>	<b>5437-1MT-10WM</b> <b>5437-2MT-10WM</b> <b>5437-3MT-10WM</b> <b>5437-4MT-10WM</b> <b>5437-5MT-10WM</b>
<b>FIXTURE</b>	FLEXIBLE LED
<b>BENDING</b>	3D
<b>LIGHT SOURCE</b>	LED
<b>POWER</b>	10W/MT
<b>SUPPLY</b>	24 Vdc
<b>PROTECTION</b>	POLARITY REVERSE
<b>DIMMABLE</b>	YES
<b>BEAM</b>	WIDE
<b>SCREEN</b>	OPAL
<b>LED COLOUR</b>	3000K CRI >90 LMN 678lm/m 1mt 229lx 2mt 57lx 3mt 25lx
<b>IP RATE</b>	IP67
<b>IK RATE</b>	IK9
<b>MOUNTING SYSTEM</b>	NR. 3 CLIPS/MT
<b>MATERIALS</b>	SPECIAL SILICONE
<b>OPTIONAL</b>	
<b>LED COLOUR</b>	2700K - 4000K

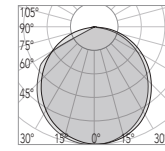



# duneflex

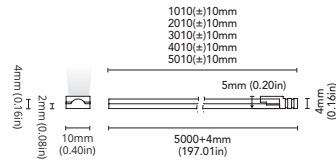

<b>CODE</b>	<b>5440-1MT-10WM</b> <b>5440-2MT-10WM</b> <b>5440-3MT-10WM</b> <b>5440-4MT-10WM</b> <b>5440-5MT-10WM</b>
<b>FIXTURE</b>	FLEXIBLE LED
<b>BENDING</b>	TOP
<b>LIGHT SOURCE</b>	LED
<b>POWER</b>	10W/MT
<b>SUPPLY</b>	24 Vdc
<b>PROTECTION</b>	POLARITY REVERSE
<b>DIMMABLE</b>	YES
<b>BEAM</b>	WIDE
<b>SCREEN</b>	OPAL
<b>LED COLOUR</b>	3000K CRI >90 LMN 698lm/m 1mt 196lx 2mt 49lx 3mt 22lx
<b>IP RATE</b>	IP65
<b>MOUNTING SYSTEM</b>	NR. 3 CLIPS/MT
<b>MATERIALS</b>	SPECIAL SILICONE
<b>OPTIONAL</b>	
<b>LED COLOUR</b>	2700K - 4000K

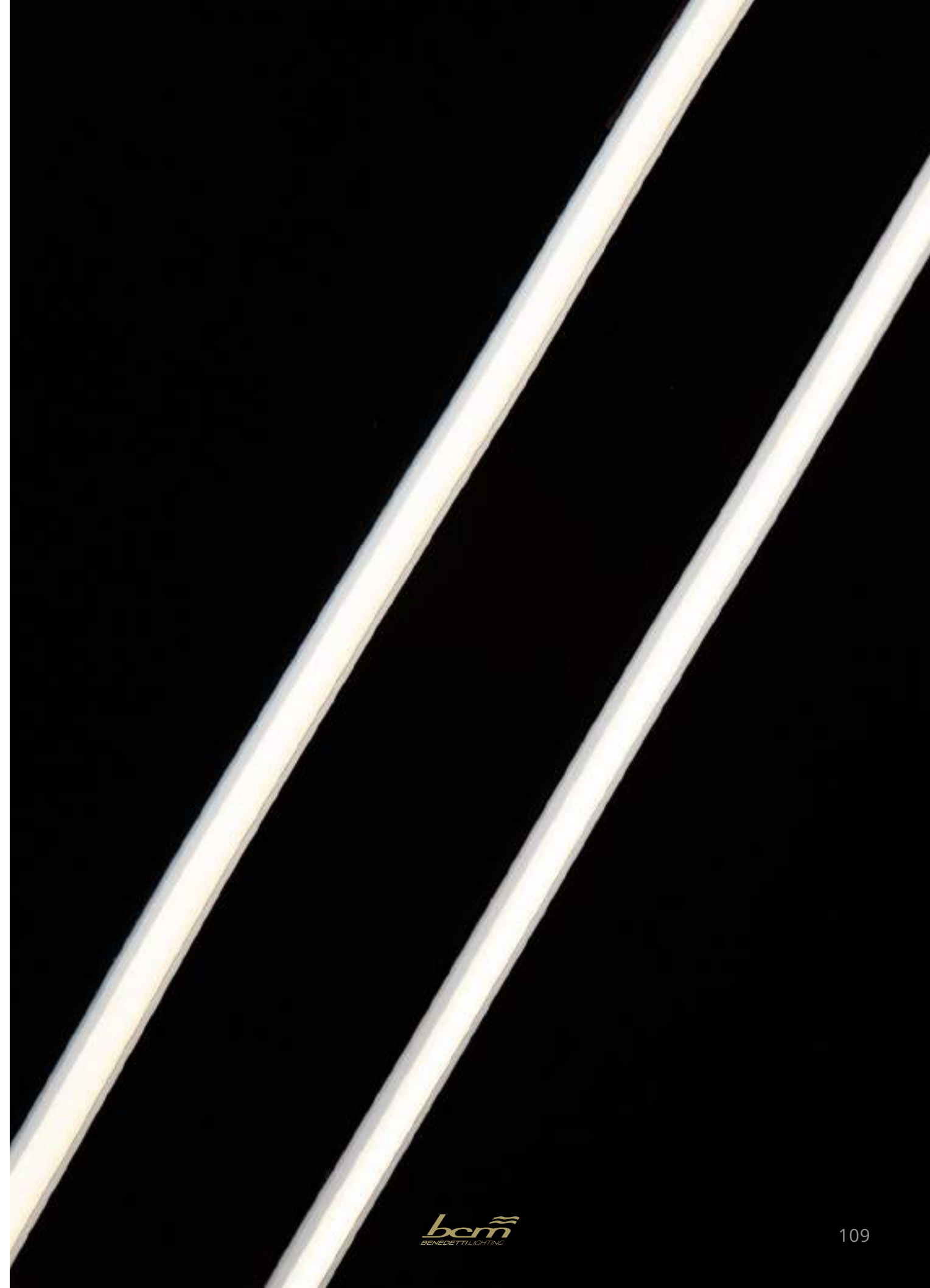
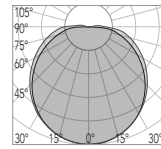





# round smooth

. S

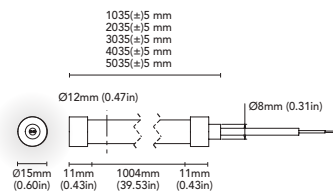

. M

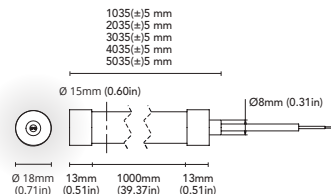

. B

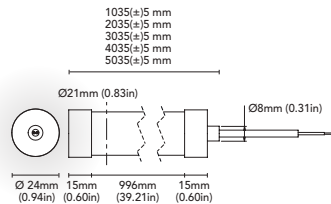

CODE

5421-1MT-8WM  
 5421-2MT-8WM  
 5421-3MT-8WM  
 5421-4MT-8WM  
 5421-5MT-8WM

FIXTURE

FLEXIBLE LED

BENDING

3D

LIGHT SOURCE

LED

POWER

8W/MT

SUPPLY

24 Vdc

PROTECTION

POLARITY REVERSE

DIMMABLE

YES

BEAM

WIDE

SCREEN

OPAL

LED COLOUR

3000K

CRI >90

LMN 618lm/m

1mt 71lx

2mt 18lx

3mt 8lx

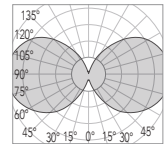

IP RATE

IP67

MOUNTING SYSTEM

NR. 3 CLIPS/MT

MATERIALS

SILICONE

OPTIONAL

LED COLOUR

2700K - 4000K

5423-1MT-10WM  
 5423-2MT-10WM  
 5423-3MT-10WM  
 5423-4MT-10WM  
 5423-5MT-10WM

FLEXIBLE LED

3D

LED

10W/MT

24 Vdc

POLARITY REVERSE

YES

WIDE

OPAL

3000K

CRI >90

LMN 912lm/m

1mt 74lx

2mt 19lx

3mt 8lx

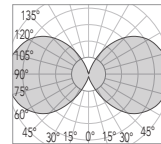

IP67

NR. 3 CLIPS/MT

SILICONE

2700K - 4000K

5425-1MT-10WM  
 5425-2MT-10WM  
 5425-3MT-10WM  
 5425-4MT-10WM  
 5425-5MT-10WM

FLEXIBLE LED

3D

LED

10W/MT

24 Vdc

POLARITY REVERSE

YES

WIDE

OPAL

3000K

CRI >90

LMN 835lm/m

1mt 89lx

2mt 22lx

3mt 10lx

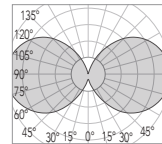

IP67

NR. 3 CLIPS/MT

SILICONE

2700K - 4000K



# round knit

. S

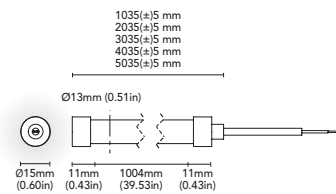

. M

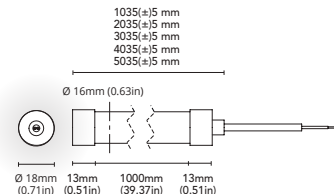

. B

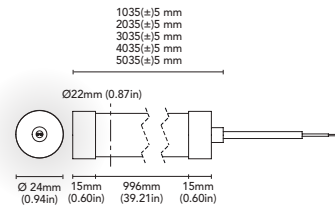

<b>CODE</b>	<b>5422-1MT-8WM</b> <b>5422-2MT-8WM</b> <b>5422-3MT-8WM</b> <b>5422-4MT-8WM</b> <b>5422-5MT-8WM</b>
<b>FIXTURE</b>	FLEXIBLE LED
<b>BENDING</b>	3D
<b>LIGHT SOURCE</b>	LED
<b>POWER</b>	8W/MT
<b>SUPPLY</b>	24 Vdc
<b>PROTECTION</b>	POLARITY REVERSE
<b>DIMMABLE</b>	YES
<b>BEAM</b>	WIDE
<b>SCREEN</b>	KNIT
<b>LED COLOUR</b>	3000K CRI >90 LMN 562lm/m 1mt 45lx 2mt 11lx 3mt 5lx
<b>IP RATE</b>	IP67
<b>MOUNTING SYSTEM</b>	NR. 3 CLIPS/MT
<b>MATERIALS</b>	SILICONE, NYLON
<b>OPTIONAL LED COLOUR</b>	2700K - 4000K

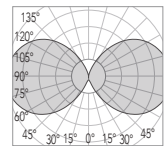

<b>CODE</b>	<b>5424-1MT-10WM</b> <b>5424-2MT-10WM</b> <b>5424-3MT-10WM</b> <b>5424-4MT-10WM</b> <b>5424-5MT-10WM</b>
<b>FIXTURE</b>	FLEXIBLE LED
<b>BENDING</b>	3D
<b>LIGHT SOURCE</b>	LED
<b>POWER</b>	10W/MT
<b>SUPPLY</b>	24 Vdc
<b>PROTECTION</b>	POLARITY REVERSE
<b>DIMMABLE</b>	YES
<b>BEAM</b>	WIDE
<b>SCREEN</b>	KNIT
<b>LED COLOUR</b>	3000K CRI >90 LMN 811lm/m 1mt 77lx 2mt 19lx 3mt 9lx
<b>IP RATE</b>	IP67
<b>MOUNTING SYSTEM</b>	NR. 3 CLIPS/MT
<b>MATERIALS</b>	SILICONE, NYLON
<b>OPTIONAL LED COLOUR</b>	2700K - 4000K

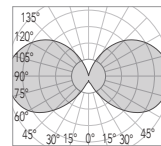

<b>CODE</b>	<b>5426-1MT-10WM</b> <b>5426-2MT-10WM</b> <b>5426-3MT-10WM</b> <b>5426-4MT-10WM</b> <b>5426-5MT-10WM</b>
<b>FIXTURE</b>	FLEXIBLE LED
<b>BENDING</b>	3D
<b>LIGHT SOURCE</b>	LED
<b>POWER</b>	10W/MT
<b>SUPPLY</b>	24 Vdc
<b>PROTECTION</b>	POLARITY REVERSE
<b>DIMMABLE</b>	YES
<b>BEAM</b>	WIDE
<b>SCREEN</b>	KNIT
<b>LED COLOUR</b>	3000K CRI >90 LMN 728lm/m 1mt 70lx 2mt 18lx 3mt 8lx
<b>IP RATE</b>	IP67
<b>MOUNTING SYSTEM</b>	NR. 3 CLIPS/MT
<b>MATERIALS</b>	SILICONE, NYLON
<b>OPTIONAL LED COLOUR</b>	2700K - 4000K

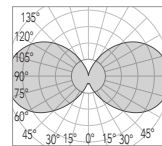



# neonflex 1010

## • 3view

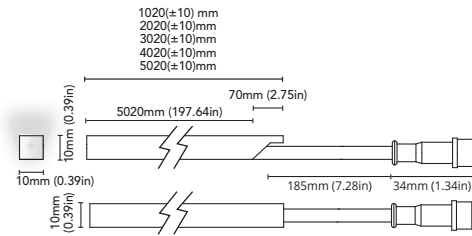

## • 3view fc

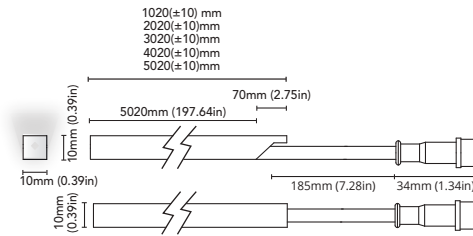

CODE	<b>5404-1MT-10WM</b> <b>5404-2MT-10WM</b> <b>5404-3MT-10WM</b> <b>5404-4MT-10WM</b> <b>5404-5MT-10WM</b>
FIXTURE	FLEXIBLE LED
BENDING	TOP
LIGHT SOURCE	LED
POWER	10W/MT
SUPPLY	24 Vdc
PROTECTION	POLARITY REVERSE
DIMMABLE	YES
BEAM	WIDE
SCREEN	OPAL
LED COLOUR	3000K CRI >90 LMN 690lm/m 1mt 116lx 2mt 29lx 3mt 13lx
IP RATE	IP68
MOUNTING SYSTEM	NR. 3 CLIPS/MT
MATERIALS	PU
OPTIONAL LED COLOUR	2700K - 4000K

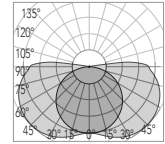

CODE	<b>5415-1MT-10WM</b> <b>5415-2MT-10WM</b> <b>5415-3MT-10WM</b> <b>5415-4MT-10WM</b> <b>5415-5MT-10WM</b>
FIXTURE	FLEXIBLE LED
BENDING	TOP
LIGHT SOURCE	LED
POWER	10W/MT
SUPPLY	24 Vdc
PROTECTION	POLARITY REVERSE
DIMMABLE	YES
BEAM	WIDE
SCREEN	OPAL
LED COLOUR	3000K CRI >90 LMN 591lm/m 1mt 99lx 2mt 25lx 3mt 11lx
IP RATE	IP68
MOUNTING SYSTEM	NR. 3 CLIPS/MT
MATERIALS	PU
OPTIONAL LED COLOUR	2700K - 4000K

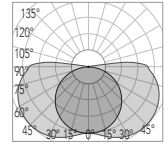



# neonflex 0606

0606 side

. side

. top

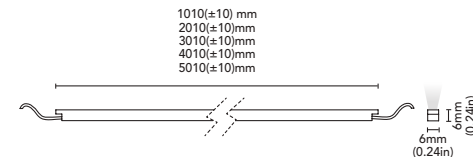
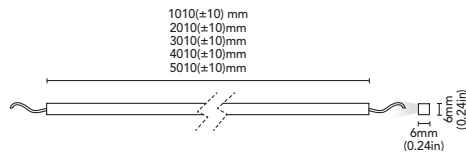

CODE

**5431-1MT-6WM**  
**5431-2MT-6WM**  
**5431-3MT-6WM**  
**5431-4MT-6WM**  
**5431-5MT-6WM**

FIXTURE	FLEXIBLE LED LIGHTING SOLUTION
BENDING	SIDE
LIGHT SOURCE	LED
POWER	6W/MT
SUPPLY	24 Vdc
PROTECTION	POLARITY REVERSE
DIMMABLE	YES
BEAM	WIDE
SCREEN	OPAL

LED COLOUR	3000K
CRI	>90
LMN	330lm/m
1mt	94lx
2mt	24lx
3mt	10lx

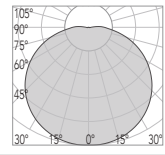

IP RATE	IP68
MOUNTING SYSTEM	NR. 3 CLIPS/MT
MATERIALS	PU

OPTIONAL LED COLOUR	2700K - 4000K
---------------------	---------------

**5430-1MT-6WM**  
**5430-2MT-6WM**  
**5430-3MT-6WM**  
**5430-4MT-6WM**  
**5430-5MT-6WM**

FIXTURE	FLEXIBLE LED LIGHTING SOLUTION
BENDING	TOP
LIGHT SOURCE	LED
POWER	6W/MT
SUPPLY	24 Vdc
PROTECTION	POLARITY REVERSE
DIMMABLE	YES
BEAM	WIDE
SCREEN	OPAL

LED COLOUR	3000K
CRI	>90
LMN	433lm/m
1mt	97lx
2mt	24lx
3mt	11lx

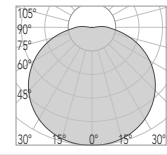

IP RATE	IP68
MOUNTING SYSTEM	NR. 3 CLIPS/MT
MATERIALS	PU

OPTIONAL LED COLOUR	2700K - 4000K
---------------------	---------------



0606 top

# profiles neonflex

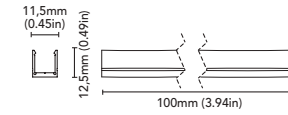
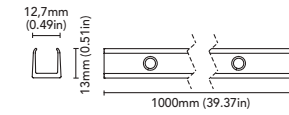
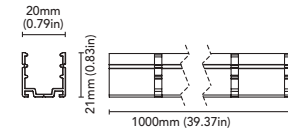
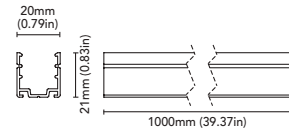
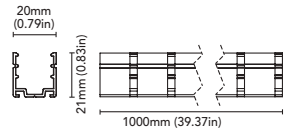
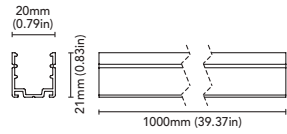

**CODE** 5400-PRO1

X ART. 5437/5438/5439-1MT

**FIXTURE** PLASTIC PROFILE

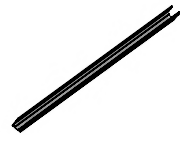

**CODE** 5400-PRO1F

X ART. 5437/5438/5439-1MT

**FIXTURE** FLEXIBLE PLASTIC PROFILE



**CODE** 5400-PRO2

X ART. 5437/5438/5439-1MT

**FIXTURE** ALUMINIUM PROFILE



**CODE** 5400-PRO2F

X ART. 5437/5438/5439-1MT

**FIXTURE** FLEXIBLE ALUMINIUM PROFILE

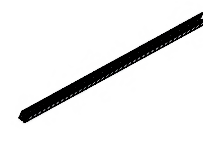

**CODE** 5400-PRO3

ART 5404/5415-1MT

**FIXTURE** PLASTIC PROFILE



**CODE** 5400-PRO4

X ART. 5404/5415-1MT

**FIXTURE** ALUMINIUM PROFILE

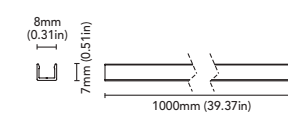
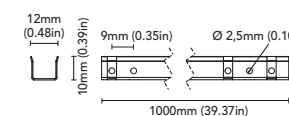
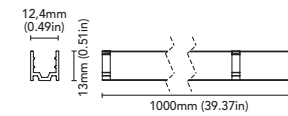
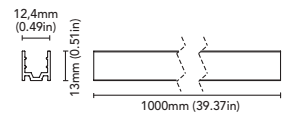
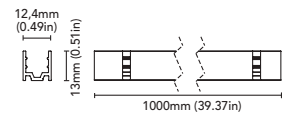
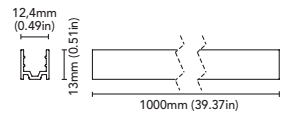
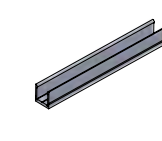

**CODE** 5400-PRO5

X ART. 5434/5435/5436-1MT

**FIXTURE** PLASTIC PROFILE

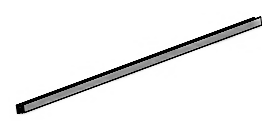

**CODE** 5400-PRO5F

X ART. 5434/5435/5436-1MT

**FIXTURE** FLEXIBLE PLASTIC PROFILE

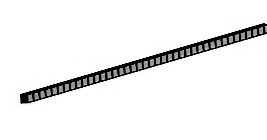

**CODE** 5400-PRO6

X ART. 5434/5435/5436-1MT

**FIXTURE** ALUMINIUM PROFILE

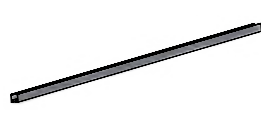

**CODE** 5400-PRO6F

X ART. 5434/5435/5436-1MT

**FIXTURE** FLEXIBLE ALUMINIUM PROFILE

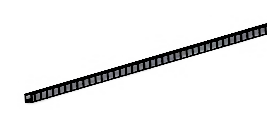

**CODE** 5400-PRO6MF

X ART. 5434/5435/5436-1MT

**FIXTURE** FLEXIBLE STAINLESS STEEL PROFILE

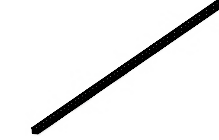

**CODE** 5400-PRO8

X ART. 5430/5431-1MT

**FIXTURE** ALUMINIUM PROFILE

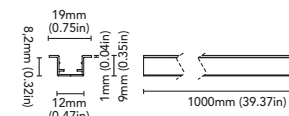
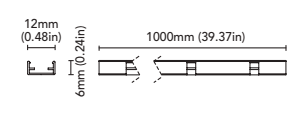
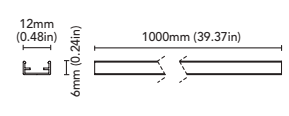
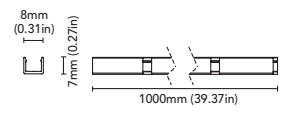
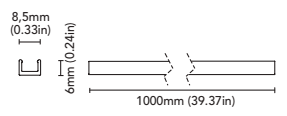

**CODE** 5400-PRO9

X ART. 5432/5433-1MT

**FIXTURE** ALUMINIUM PROFILE



**CODE** 5400-PRO9F

X ART. 5432/5433-1MT

**FIXTURE** FLEXIBLE ALUMINIUM PROFILE



**CODE** 5400-PRO10

X ART. 5440-1MT

**FIXTURE** ALUMINIUM PROFILE



**CODE** 5400-PRO10F

X ART. 5440-1MT

**FIXTURE** FLEXIBLE ALUMINIUM PROFILE



**CODE** 5400-PRO10R

X ART. 5440-1MT

**FIXTURE** RECESSED ALUMINIUM PROFILE



# accessories neonflex

## . Kit

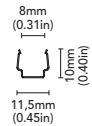
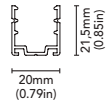

CODE **5400-KIT1**

FIXTURE X ART. 5437/5438/5439  
KIT (CLIP+SCREWS)

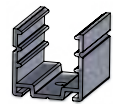

CODE **5400-KIT2**

FIXTURE X ART. 5404  
KIT (CLIP+SCREWS)



CODE **5400-KIT3**

FIXTURE X ART. 5434/5435/5436  
KIT (CLIP+SCREWS)



CODE **5400-KIT4**

FIXTURE X ART. 5430/5431  
KIT (CLIP+SCREWS)



CODE **5400-KIT5**

FIXTURE X ART. 5432/5433  
KIT (CLIP+SCREWS)



CODE **5400-KIT6**

FIXTURE X ART. 5440  
KIT (CLIP+SCREWS)

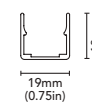
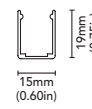
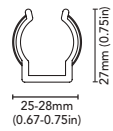
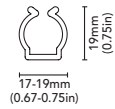

CODE **5400-KIT7**

FIXTURE X ART. 5421/5422/5423/5424  
KIT (CLIP+SCREWS)



CODE **5400-KIT8**

FIXTURE X ART. 5425/5426  
KIT (CLIP+SCREWS)



CODE **5400-KIT9**

FIXTURE X ART. 5418  
KIT (CLIP+SCREWS)



CODE **5400-KIT10**

FIXTURE X ART. 5417  
KIT (CLIP+SCREWS)

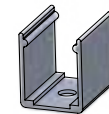

CODE **5400-KIT11**

FIXTURE X ART. 5416  
KIT (CLIP+SCREWS)



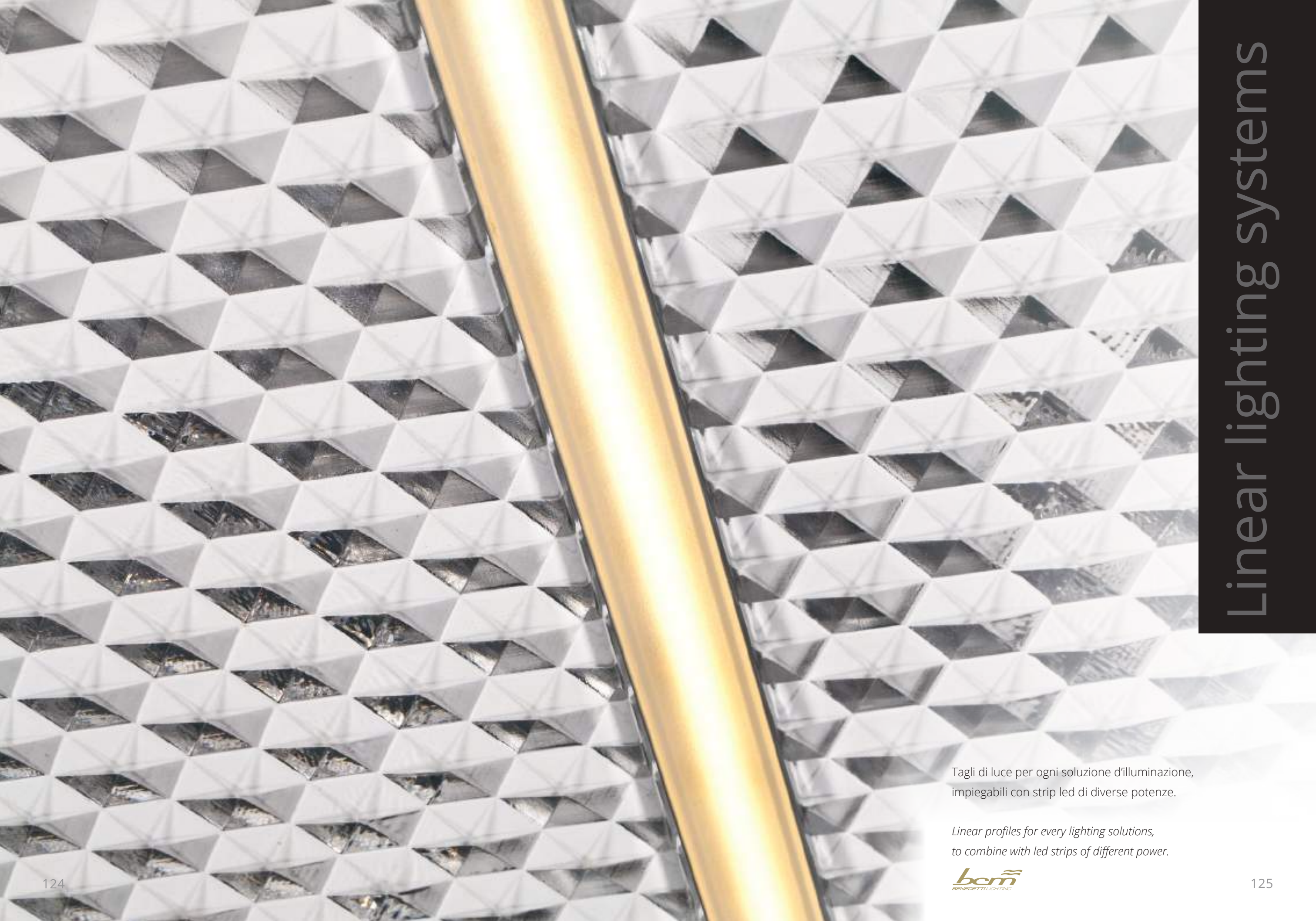

# Linear lighting systems

Tagli di luce per ogni soluzione d'illuminazione, impiegabili con strip led di diverse potenze.

*Linear profiles for every lighting solutions, to combine with led strips of different power.*

**bcn**  
BENEDETTI LIGHTING

# mini blade

## one . A

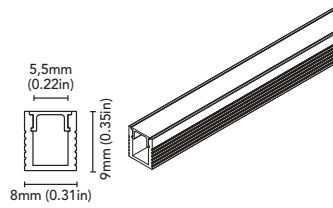

## two . B

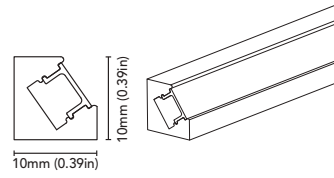

## three . C

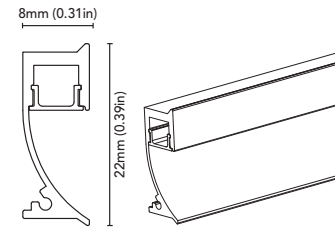

CODE	<b>5070-P06</b>
FIXTURE	PROFILE
SCREEN	OPAL
MATERIALS	BODY: ANODIZED ALUMINIUM
MOUNTING SYSTEM	CLIPS

CODE	<b>5070-P07</b>
FIXTURE	PROFILE
SCREEN	OPAL
MATERIALS	BODY: ANODIZED ALUMINIUM
MOUNTING SYSTEM	CLIPS

CODE	<b>5070-P08</b>
FIXTURE	PROFILE
SCREEN	OPAL
MATERIALS	BODY: ANODIZED ALUMINIUM
MOUNTING SYSTEM	

### ACCESSORIES

PLASTIC END CAPS 2X	5070-PEC06	
---------------------	------------	--

PLASTIC END CAPS 2X	5070-PEC07	
---------------------	------------	--

PLASTIC END CAPS 2X	5070-MEC08	
---------------------	------------	--

BAND CLIP	5070-MC06	
-----------	-----------	--

BAND CLIP	5070-MC07	
-----------	-----------	--

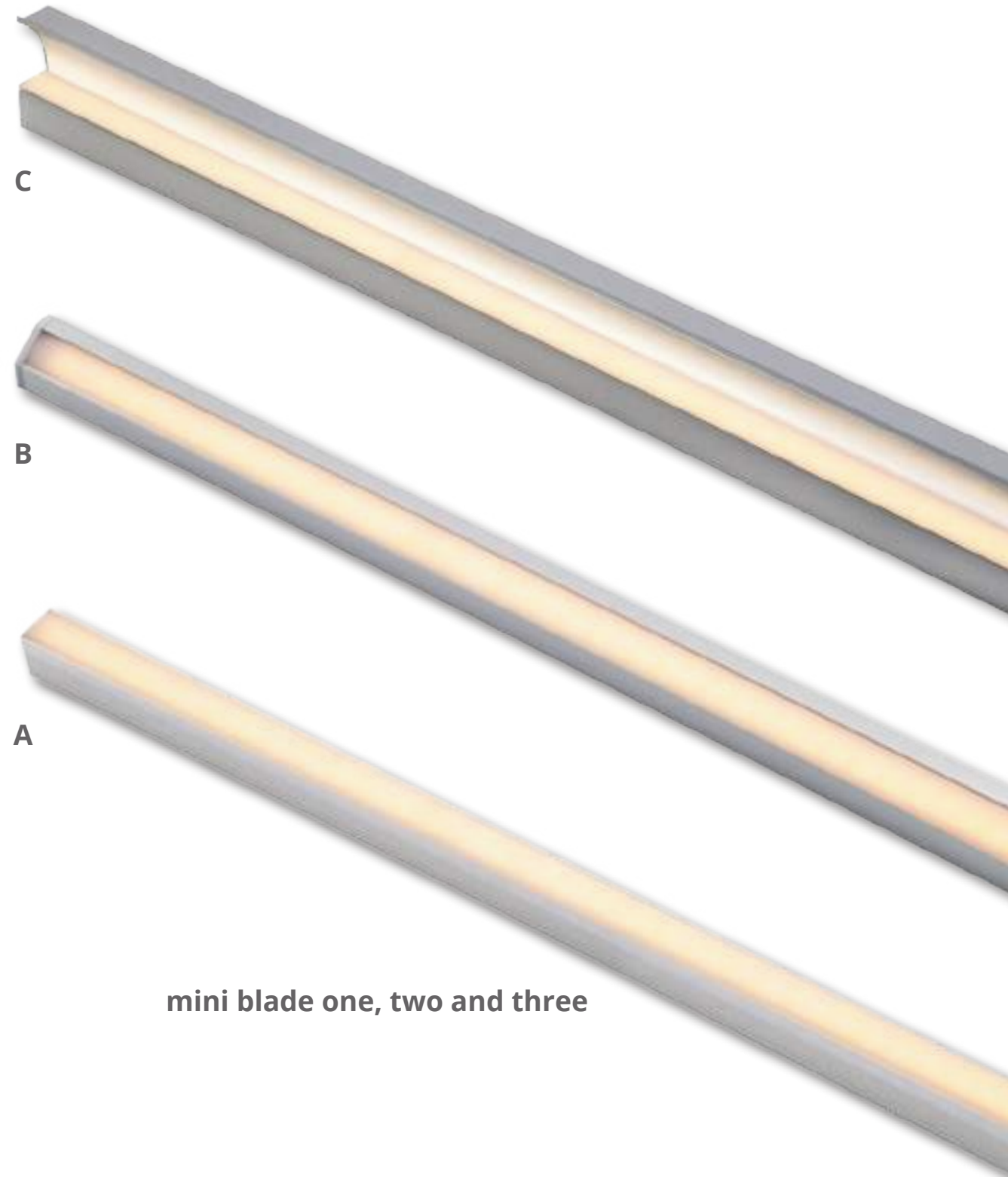

mini blade one, two and three

# blade one

## one . A

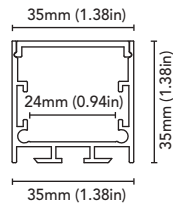

## one . B

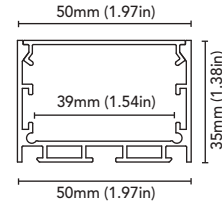

## one . C

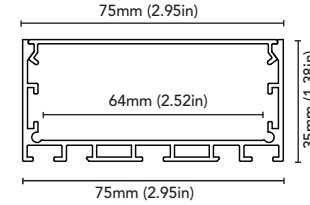

<b>CODE</b>	<b>5070-P18</b>	<b>5070-P46</b>	<b>5070-P48</b>
<b>FIXTURE</b>	PROFILE	PROFILE	PROFILE
<b>SCREEN</b>	OPAL	OPAL	OPAL
<b>MATERIALS</b>	BODY: ANODIZED ALUMINIUM	BODY: ANODIZED ALUMINIUM	BODY: ANODIZED ALUMINIUM
<b>MOUNTING SYSTEM</b>	CLIPS	CLIPS	CLIPS
<b>ACCESSORIES</b>			
<b>CAPS 2X</b>	5070-MEC18 	5070-MEC46 	5070-MEC48 
<b>T CONNECTION</b>	5070-C18T 	5070-C46T 	5070-C48T 
<b>L CONNECTION</b>	5070-C18L 	5070-C46L 	5070-C48L 
<b>X CONNECTION</b>	5070-C18X 	5070-C46X 	5070-C48X 
<b>BAND CLIP</b>	5070-SPR18 	5070-SPR46 	5070-SPR48 

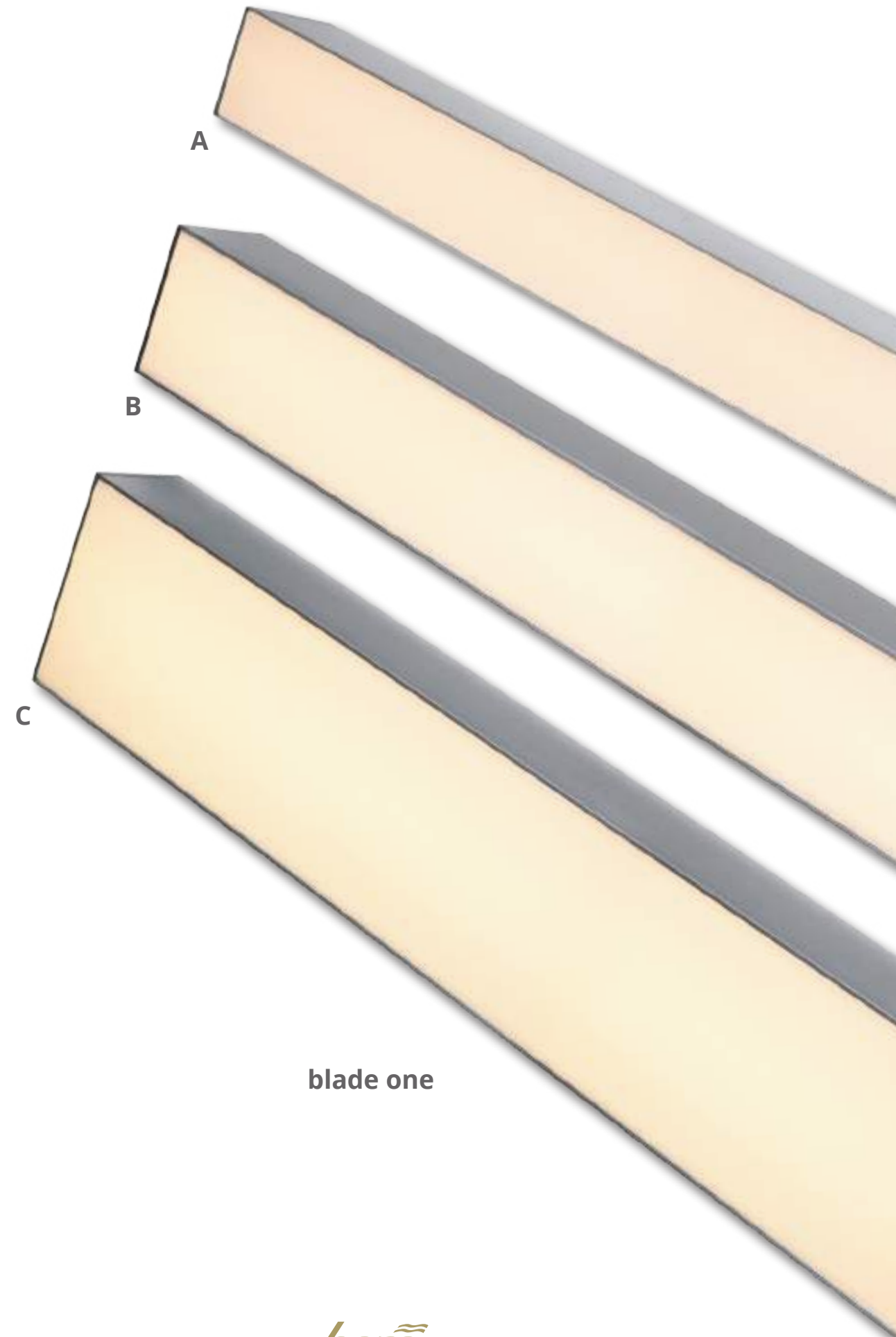

blade one

# blade two

## two . A

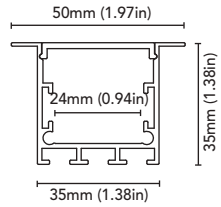



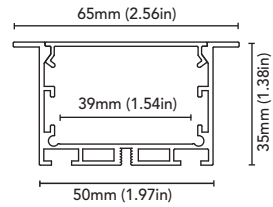



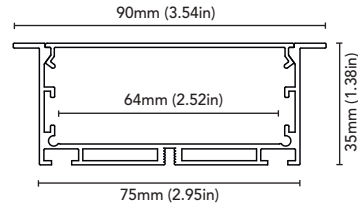











## two . B



## two . C



CODE	5070-P17	5070-P45	5070-P47
FIXTURE	PROFILE	PROFILE	PROFILE
SCREEN	OPAL	OPAL	OPAL
MATERIALS	BODY: ANODIZED ALUMINIUM	BODY: ANODIZED ALUMINIUM	BODY: ANODIZED ALUMINIUM
MOUNTING SYSTEM	SPRINGS OR FIXING BRIDGE	SPRINGS OR FIXING BRIDGE	SPRINGS OR FIXING BRIDGE
ACCESSORIES			
CAPS 2X	5070-MEC17 	5070-MEC45 	5070-MEC47 
T CONNECTION	5070-C17T 	5070-C45T 	5070-C47T 
L CONNECTION	5070-C17L 	5070-C45L 	5070-C47L 
X CONNECTION	5070-C17X 	5070-C45X 	5070-C47X 
FIXING BRIDGE	5070-MCB17 	5070-MCB45 	5070-MCB47 
SPRINGS	5070-SPR17 	5070-SPR45 	5070-SPR47 

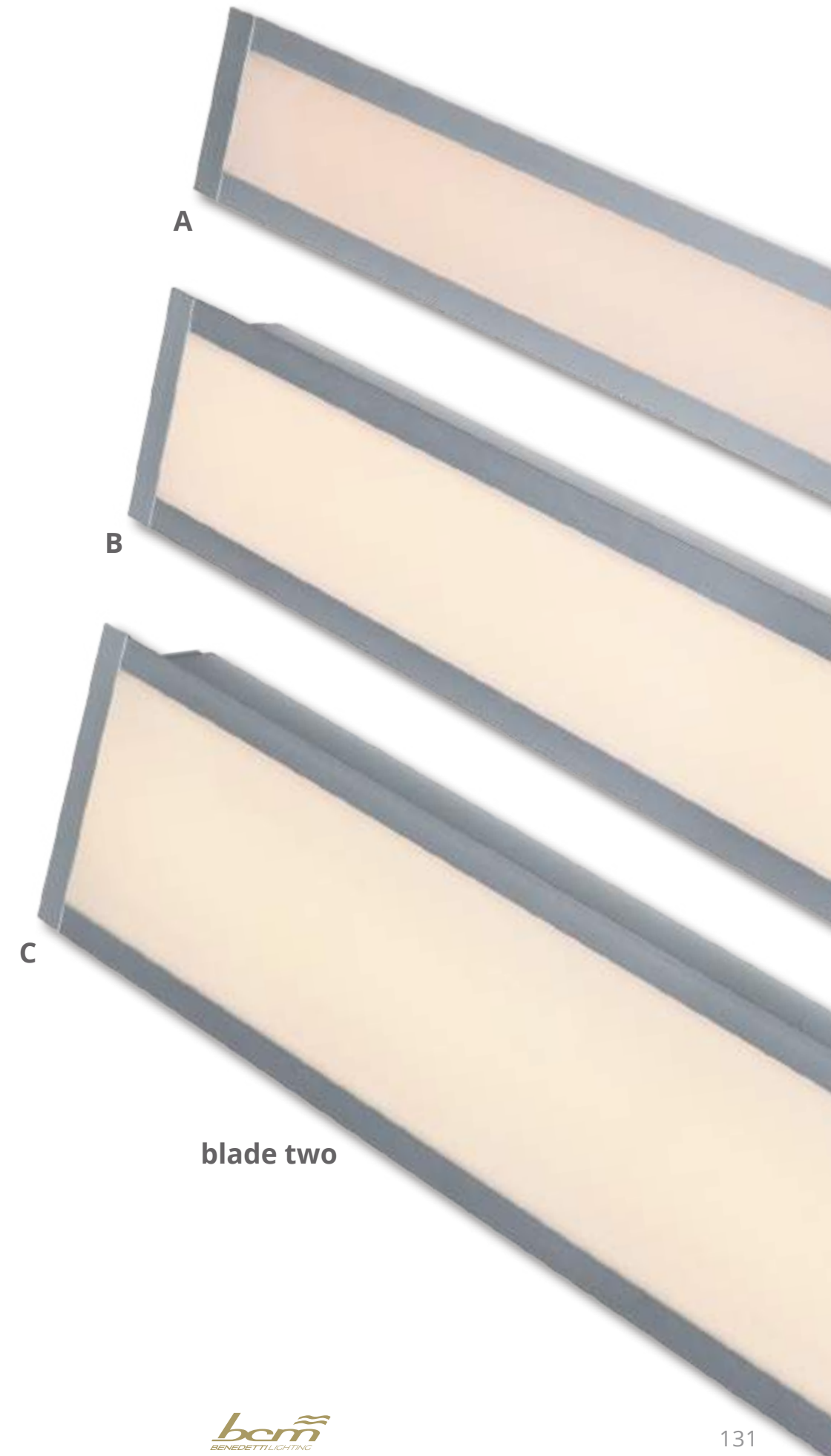

blade two

# blade three

## three . A

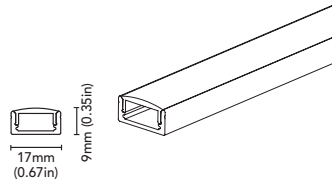

## three . B

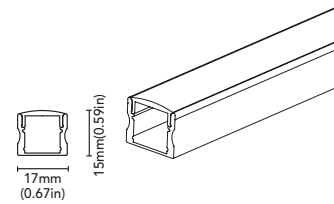

## three . C

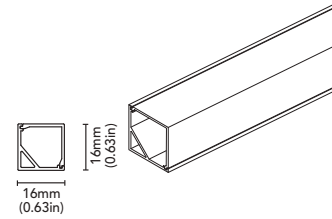

CODE	<b>5070-P02</b>
FIXTURE	PROFILE
SCREEN	OPAL
MATERIALS	BODY: ANODIZED ALUMINIUM
MOUNTING SYSTEM	CLIPS

CODE	<b>5070-P04</b>
FIXTURE	PROFILE
SCREEN	OPAL
MATERIALS	BODY: ANODIZED ALUMINIUM
MOUNTING SYSTEM	CLIPS

CODE	<b>5070-P05</b>
FIXTURE	PROFILE
SCREEN	OPAL
MATERIALS	BODY: ANODIZED ALUMINIUM
MOUNTING SYSTEM	CLIPS

OPTIONAL SCREEN	FROSTED
-----------------	---------

OPTIONAL SCREEN	FROSTED
-----------------	---------

OPTIONAL SCREEN	FROSTED
-----------------	---------

### ACCESSORIES

CAPS 2X	5070-PEC02	
---------	------------	--

CAPS 2X	5070-PEC04	
---------	------------	--

CAPS 2X	5070-PEC05	
---------	------------	--

PLASTIC CLIP	5070-PC02	
--------------	-----------	--

PLASTIC CLIP	5070-PC04	
--------------	-----------	--

PLASTIC CLIP	5070-PC05	
--------------	-----------	--

METAL CLIP	5070-MC02	
------------	-----------	--

METAL CLIP	5070-MC04	
------------	-----------	--

METAL CLIP	5070-MC05	
------------	-----------	--

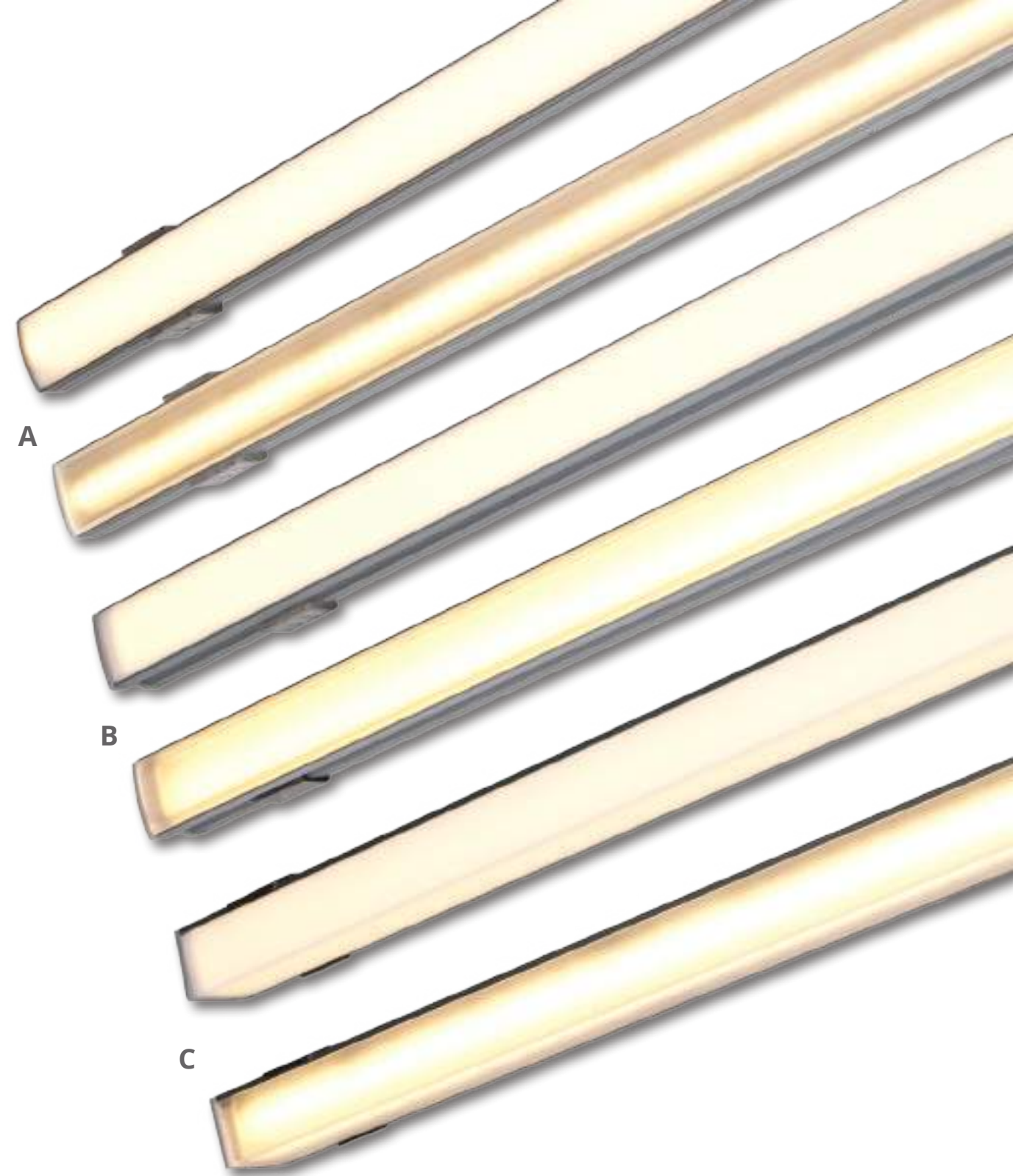

blade three

# blade four

## four . A

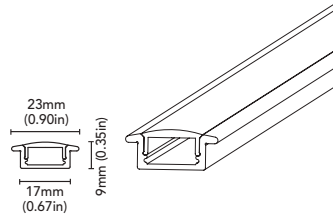

## four . B

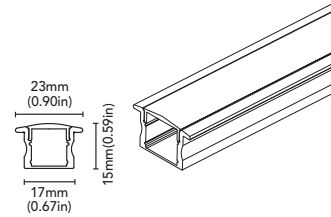

CODE	<b>5070-P01</b>
FIXTURE	PROFILE
SCREEN	OPAL
MATERIALS	BODY: ANODIZED ALUMINIUM
OPTIONAL	
SCREEN	FROSTED
ACCESSORIES	
CAPS 2X	5070-PEC01 

CODE	<b>5070-P03</b>
FIXTURE	PROFILE
SCREEN	OPAL
MATERIALS	BODY: ANODIZED ALUMINIUM
OPTIONAL	
SCREEN	FROSTED
ACCESSORIES	
CAPS 2X	5070-PEC03 



# blade five

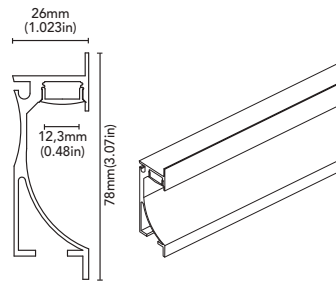

CODE	<b>5070 -P23</b>
FIXTURE	PROFILE
SCREEN	OPAL
MATERIALS	BODY: ANODIZED ALUMINIUM
OPTIONAL	
SCREEN	FROSTED
ACCESSORIES	
CAPS 2X	5070-PEC23 



blade five



# miniflex

## • 240-TOP

## • 240IP-TOP

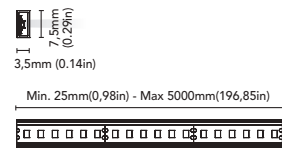
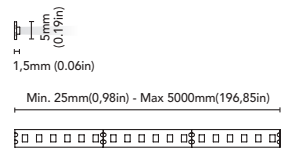

<b>CODE</b>	<b>5337-240NV-10WM</b>
<b>FIXTURE</b>	SLIM FLEX LED
<b>BENDING</b>	TOP
<b>LIGHT SOURCE</b>	LED
<b>POWER</b>	240LED/MT - 10W/MT
<b>SUPPLY</b>	24 Vdc
<b>PROTECTION</b>	POLARITY REVERSE
<b>DIMMABLE</b>	YES
<b>BEAM</b>	WIDE
<b>LED COLOUR</b>	3000K CRI >90 LMN 1154lm/m 1mt 390lx 2mt 97lx 3mt 43lx
<b>IP RATE</b>	IP20
<b>MOUNTING SYSTEM</b>	ADHESIVE TAPE
<b>OPTIONAL LED COLOUR</b>	2700K - 4000K

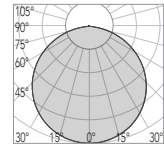

<b>CODE</b>	<b>5337-240NVP-10WM</b>
<b>FIXTURE</b>	SLIM FLEX LED
<b>BENDING</b>	TOP
<b>LIGHT SOURCE</b>	LED
<b>POWER</b>	240LED/MT - 10W/MT
<b>SUPPLY</b>	24 Vdc
<b>PROTECTION</b>	POLARITY REVERSE
<b>DIMMABLE</b>	YES
<b>BEAM</b>	WIDE
<b>LED COLOUR</b>	3000K CRI >90 LMN 1047lm/m 1mt 365lx 2mt 91lx 3mt 41lx
<b>IP RATE</b>	IP65
<b>MOUNTING SYSTEM</b>	ADHESIVE TAPE
<b>OPTIONAL LED COLOUR</b>	2700K - 4000K

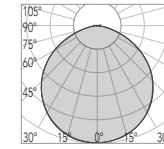



# flex

## . 60-TOP

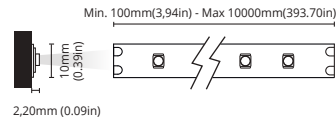

## . 60IP-TOP

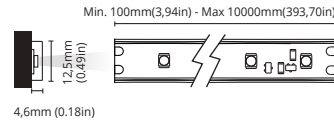

## . 120-TOP

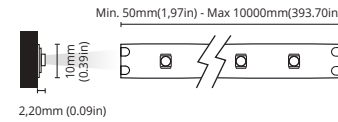

## . 120IP-TOP

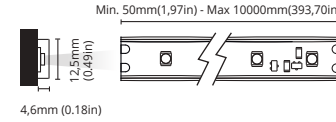

## . 240-TOP

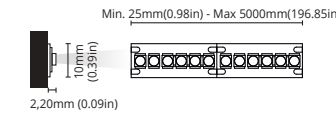

CODE	<b>5338-60MC-5WM</b>
FIXTURE	FLEX LED
BENDING	TOP
LIGHT SOURCE	LED
POWER	60LED/MT - 5W/MT
SUPPLY	16-32 Vdc
PROTECTION	POLARITY REVERSE
DIMMABLE	YES
BEAM	WIDE
LED COLOUR	3000K CRI >90 LMN 435lm/m 1mt 147lx 2mt 37lx 3mt 16lx
IP RATE	IP20
MOUNTING SYSTEM	ADHESIVE TAPE
OPTIONAL LED COLOUR	2700K - 4000K

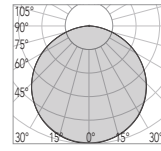

CODE	<b>5338-60MCP-5WM</b>
FIXTURE	FLEX LED
BENDING	TOP
LIGHT SOURCE	LED
POWER	60LED/MT - 5W/MT
SUPPLY	16-32 Vdc
PROTECTION	POLARITY REVERSE
DIMMABLE	YES
BEAM	WIDE
LED COLOUR	3000K CRI >90 LMN 345lm/m 1mt 124lx 2mt 30lx 3mt 13lx
IP RATE	IP67
MOUNTING SYSTEM	ADHESIVE TAPE
OPTIONAL LED COLOUR	2700K - 4000K

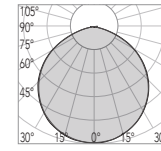

CODE	<b>5338-120MC-10WM</b>
FIXTURE	FLEX LED
BENDING	TOP
LIGHT SOURCE	LED
POWER	120LED/MT - 10W/MT
SUPPLY	16-32 Vdc
PROTECTION	POLARITY REVERSE
DIMMABLE	YES
BEAM	WIDE
LED COLOUR	3000K CRI >90 LMN 929lm/m 1mt 314lx 2mt 78lx 3mt 35 lx
IP RATE	IP20
MOUNTING SYSTEM	ADHESIVE TAPE
OPTIONAL LED COLOUR	2700K - 4000K

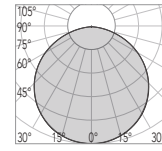

CODE	<b>5338-120MCP-10WM</b>
FIXTURE	FLEX LED
BENDING	TOP
LIGHT SOURCE	LED
POWER	120LED/MT - 10W/MT
SUPPLY	16-32 Vdc
PROTECTION	POLARITY REVERSE
DIMMABLE	YES
BEAM	WIDE
LED COLOUR	3000K CRI >90 LMN 838lm/m 1mt 308lx 2mt 77lx 3mt 34lx
IP RATE	IP67
MOUNTING SYSTEM	ADHESIVE TAPE
OPTIONAL LED COLOUR	2700K - 4000K

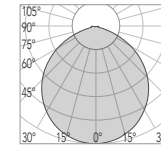

CODE	<b>5337-240MV-20WM</b>
FIXTURE	FLEX LED
BENDING	TOP
LIGHT SOURCE	LED
POWER	240LED/MT - 20W/MT
SUPPLY	24 Vdc
PROTECTION	POLARITY REVERSE
DIMMABLE	YES
BEAM	WIDE
LED COLOUR	3000K CRI >90 LMN 2037lm/m 1mt 694lx 2mt 173lx 3mt 77lx
IP RATE	IP20
MOUNTING SYSTEM	ADHESIVE TAPE
OPTIONAL LED COLOUR	2700K - 4000K

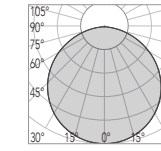

\* For proper use, install this strip on heatsink.



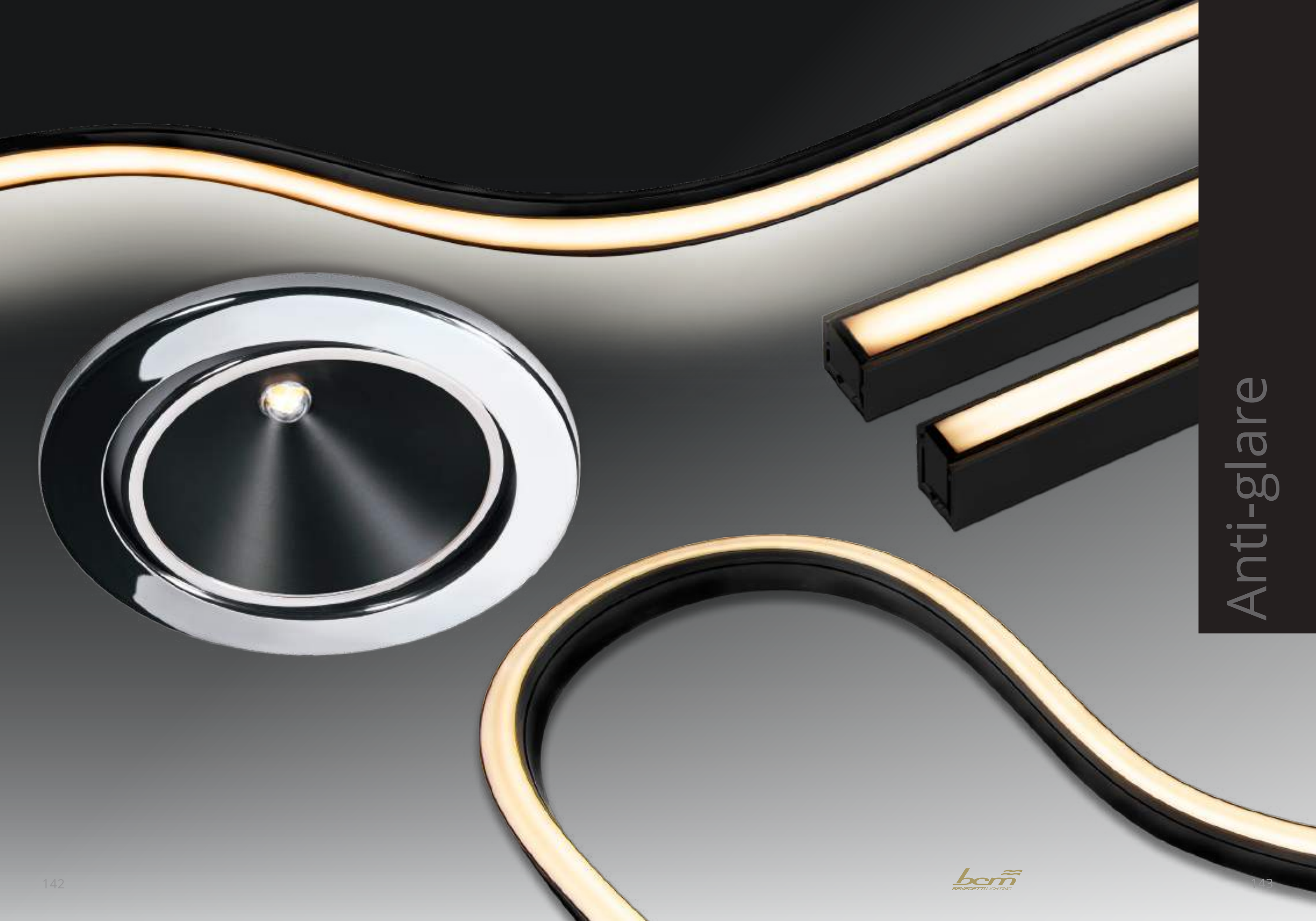

Anti-glare



# malibù ag

. 60

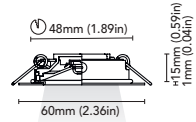

. 75

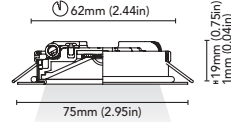

. 85

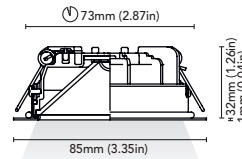

. 95

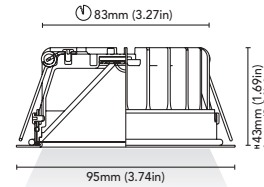

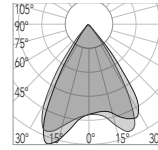
CODE	<b>3521-60A-B1.5W</b>
FIXTURE	FIXED DOWNLIGHT
ADJUSTABILITY	NO
LIGHT SOURCE	POWER LED
POWER	MAX 1,5W
SUPPLY	8-32 Vdc
PROTECTION	FUSE - POLARITY REVERSE SPIKE FILTER
DIMMABLE	YES
BEAM	WIDE
SCREEN	LENS
LED COLOUR	3000K CRI >90 LMN 87lm 1mt 63lx 2mt 16lx 3mt 7lx 
IP RATE	IP40
MATERIALS	BODY: STAINLESS STEEL AISI 316 HEATSINK: SPECIAL COMPOUND
MOUNTING SYSTEM	SPRINGS
OPTIONAL	
LED COLOUR	2700K - 4000K - RED - BLUE
IP RATE	IP66

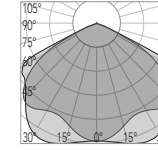
CODE	<b>3521-75A-B2W</b>
FIXTURE	FIXED DOWNLIGHT
ADJUSTABILITY	NO
LIGHT SOURCE	POWER LED
POWER	MAX 2W
SUPPLY	8-32 Vdc
PROTECTION	FUSE - POLARITY REVERSE SPIKE FILTER
DIMMABLE	YES
BEAM	WIDE
SCREEN	LENS
LED COLOUR	3000K CRI >90 LMN 196lm 1mt 63lx 2mt 16lx 3mt 7lx 
IP RATE	IP40
MATERIALS	BODY: STAINLESS STEEL AISI 316 HEATSINK: SPECIAL COMPOUND
MOUNTING SYSTEM	SPRINGS
OPTIONAL	
LED COLOUR	2700K - 4000K - (3000K+RED)
IP RATE	IP66

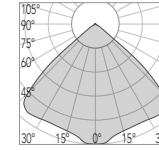
CODE	<b>3521-85A-B4W</b>
FIXTURE	FIXED DOWNLIGHT
ADJUSTABILITY	NO
LIGHT SOURCE	POWER LED
POWER	MAX 4W
SUPPLY	8-32 Vdc
PROTECTION	FUSE - POLARITY REVERSE SPIKE FILTER
DIMMABLE	YES
BEAM	WIDE
SCREEN	LENS
LED COLOUR	3000K CRI >90 LMN 249lm 1mt 120lx 2mt 30lx 3mt 13lx 
IP RATE	IP40
MATERIALS	BODY: STAINLESS STEEL AISI 316 HEATSINK: SPECIAL COMPOUND
MOUNTING SYSTEM	SPRINGS
OPTIONAL	
LED COLOUR	2700K - 4000K - (3000K+RED)
IP RATE	IP66

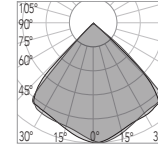
CODE	<b>3521-95A-B6W</b>
FIXTURE	FIXED DOWNLIGHT
ADJUSTABILITY	NO
LIGHT SOURCE	POWER LED
POWER	MAX 6W
SUPPLY	8-32 Vdc
PROTECTION	FUSE - POLARITY REVERSE SPIKE FILTER
DIMMABLE	YES
BEAM	WIDE
SCREEN	LENS
LED COLOUR	3000K CRI >90 LMN 286lm 1mt 165lx 2mt 41lx 3mt 18lx 
IP RATE	IP40
MATERIALS	BODY: STAINLESS STEEL AISI 316 HEATSINK: SPECIAL COMPOUND
MOUNTING SYSTEM	SPRINGS
OPTIONAL	
LED COLOUR	2700K - 4000K - (3000K+RED)
IP RATE	IP66



INNER CONE MADE FROM RECYCLED PLASTIC DERIVED FROM RECLAIMED SEA FISHING NETS

malibù ag . 85

	FINISHES	FE	23	20	4	34
		I	23			



# newport ag

. 85

. 95

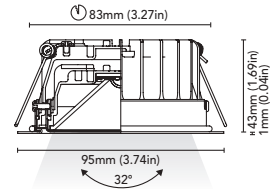
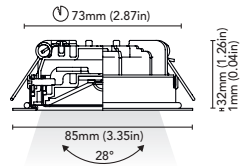

<b>CODE</b>	<b>3525-85A-B2W</b>
<b>FIXTURE</b>	ADJUSTABLE DOWNLIGHT
<b>ADJUSTABILITY</b>	△ 28°
<b>LIGHT SOURCE</b>	POWER LED
<b>POWER</b>	MAX 2W
<b>SUPPLY</b>	8-32 Vdc
<b>PROTECTION</b>	FUSE - POLARITY REVERSE SPIKE FILTER
<b>DIMMABLE</b>	YES
<b>BEAM</b>	WIDE
<b>SCREEN</b>	LENS
<b>LED COLOUR</b>	3000K CRI >90 LMN 196lm 1mt 63lx 2mt 16lx 3mt 7lx
<b>IP RATE</b>	IP40
<b>MATERIALS</b>	BODY: STAINLESS STEEL AISI 316 HEATSINK: SPECIAL COMPOUND
<b>MOUNTING SYSTEM</b>	SPRINGS
<b>OPTIONAL</b>	
<b>LED COLOUR</b>	2700K - 4000K - (3000K+RED)
<b>IP RATE</b>	IP66

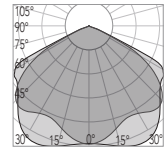

<b>CODE</b>	<b>3525-95A-B4W</b>
<b>FIXTURE</b>	ADJUSTABLE DOWNLIGHT
<b>ADJUSTABILITY</b>	△ 32°
<b>LIGHT SOURCE</b>	POWER LED
<b>POWER</b>	MAX 4W
<b>SUPPLY</b>	8-32 Vdc
<b>PROTECTION</b>	FUSE - POLARITY REVERSE SPIKE FILTER
<b>DIMMABLE</b>	YES
<b>BEAM</b>	WIDE
<b>SCREEN</b>	LENS
<b>LED COLOUR</b>	3000K CRI >90 LMN 249lm 1mt 120lx 2mt 30lx 3mt 13lx
<b>IP RATE</b>	IP40
<b>MATERIALS</b>	BODY: STAINLESS STEEL AISI 316 HEATSINK: SPECIAL COMPOUND
<b>MOUNTING SYSTEM</b>	SPRINGS
<b>OPTIONAL</b>	
<b>LED COLOUR</b>	2700K - 4000K - (3000K+RED)
<b>IP RATE</b>	IP66

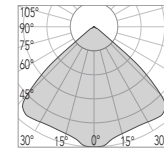

INNER CONE MADE FROM RECYCLED PLASTIC DERIVED FROM RECLAIMED SEA FISHING NETS

newport ag . 85

	<b>FINISHES</b>	<b>FE=R</b>	23	20	4	34
		<b>I</b>	23			



# orlando ag

. 60

. 75

. 85

. 95

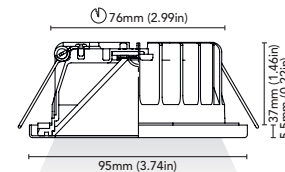
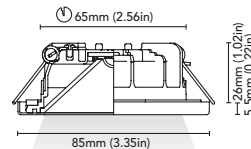
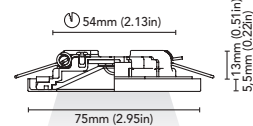
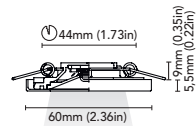

CODE	<b>3520-60A-B1.5W</b> <b>3520-60C-B1.5W</b>
FIXTURE	FIXED DOWNLIGHT
ADJUSTABILITY	NO
LIGHT SOURCE	POWER LED
POWER	MAX 1,5W
SUPPLY	8-32 Vdc
PROTECTION	FUSE - POLARITY REVERSE SPIKE FILTER
DIMMABLE	YES
BEAM	WIDE
SCREEN	LENS
LED COLOUR	3000K CRI >90 LMN 87lm 1mt 63lx 2mt 16lx 3mt 7lx
IP RATE	IP40
MATERIALS	BODY: STAINLESS STEEL AISI 316 HEATSINK: SPECIAL COMPOUND
MOUNTING SYSTEM	(A) SPRINGS (C) SCREWS
OPTIONAL	
SWITCH ON THE FRAME	
LED COLOUR	2700K - 4000K - RED - BLUE
IP RATE	IP66

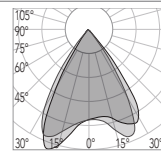

CODE	<b>3520-75A-B2W</b> <b>3520-75C-B2W</b>
FIXTURE	FIXED DOWNLIGHT
ADJUSTABILITY	NO
LIGHT SOURCE	POWER LED
POWER	MAX 2W
SUPPLY	8-32 Vdc
PROTECTION	FUSE - POLARITY REVERSE SPIKE FILTER
DIMMABLE	YES
BEAM	WIDE
SCREEN	LENS
LED COLOUR	3000K CRI >90 LMN 196lm 1mt 63lx 2mt 16lx 3mt 7lx
IP RATE	IP40
MATERIALS	BODY: STAINLESS STEEL AISI 316 HEATSINK: SPECIAL COMPOUND
MOUNTING SYSTEM	(A) SPRINGS (C) SCREWS
OPTIONAL	
SWITCH ON THE FRAME	AVAILABLE
LED COLOUR	2700K - 4000K - (3000K+RED)
IP RATE	IP66

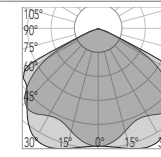

CODE	<b>3520-85A-B4W</b> <b>3520-85C-B4W</b>
FIXTURE	FIXED DOWNLIGHT
ADJUSTABILITY	NO
LIGHT SOURCE	POWER LED
POWER	MAX 4W
SUPPLY	8-32 Vdc
PROTECTION	FUSE - POLARITY REVERSE SPIKE FILTER
DIMMABLE	YES
BEAM	WIDE
SCREEN	LENS
LED COLOUR	3000K CRI >90 LMN 249lm 1mt 120lx 2mt 30lx 3mt 13lx
IP RATE	IP40
MATERIALS	BODY: STAINLESS STEEL AISI 316 HEATSINK: SPECIAL COMPOUND
MOUNTING SYSTEM	(A) SPRINGS (C) SCREWS
OPTIONAL	
SWITCH ON THE FRAME	AVAILABLE
LED COLOUR	2700K - 4000K - (3000K+RED)
IP RATE	IP66

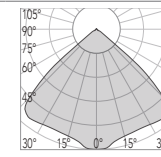

CODE	<b>3520-95A-B6W</b> <b>3520-95C-B6W</b>
FIXTURE	FIXED DOWNLIGHT
ADJUSTABILITY	NO
LIGHT SOURCE	POWER LED
POWER	MAX 6W
SUPPLY	8-32 Vdc
PROTECTION	FUSE - POLARITY REVERSE SPIKE FILTER
DIMMABLE	YES
BEAM	WIDE
SCREEN	LENS
LED COLOUR	3000K CRI >90 LMN 286lm 1mt 165lx 2mt 41lx 3mt 18lx
IP RATE	IP40
MATERIALS	BODY: STAINLESS STEEL AISI 316 HEATSINK: SPECIAL COMPOUND
MOUNTING SYSTEM	(A) SPRINGS (C) SCREWS
OPTIONAL	
SWITCH ON THE FRAME	AVAILABLE
LED COLOUR	2700K - 4000K - (3000K+RED)
IP RATE	IP66

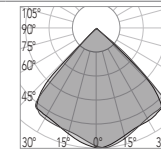

INNER CONE MADE FROM RECYCLED PLASTIC DERIVED FROM RECLAIMED SEA FISHING NETS

orlando ag . 60



FINISHES	FE	23 20 4 34
	I	23

switch on the frame





# phoenix ag

. 85

. 95

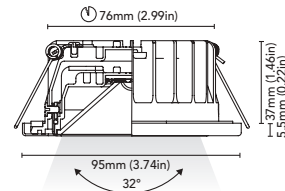
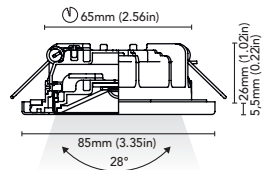

CODE	<b>3524-85A-B2W</b> <b>3524-85C-B2W</b>
FIXTURE	ADJUSTABLE DOWNLIGHT
ADJUSTABILITY	△ 28°
LIGHT SOURCE	POWER LED
POWER	MAX 2W
SUPPLY	8-32 Vdc
PROTECTION	FUSE - POLARITY REVERSE SPIKE FILTER
DIMMABLE	YES
BEAM	WIDE
SCREEN	LENS
LED COLOUR	3000K CRI >90 LMN 196lm 1mt 63lx 2mt 16lx 3mt 7lx
IP RATE	IP40
MATERIALS	BODY: STAINLESS STEEL AISI 316 HEATSINK: SPECIAL COMPOUND
MOUNTING SYSTEM	(A) SPRINGS (C) SCREWS
OPTIONAL SWITCH ON THE FRAME	AVAILABLE
LED COLOUR	2700K - 4000K - (3000K+RED)
IP RATE	IP66

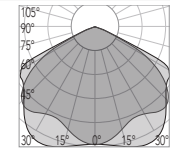

CODE	<b>3524-95A-B4W</b> <b>3524-95C-B4W</b>
FIXTURE	ADJUSTABLE DOWNLIGHT
ADJUSTABILITY	△ 32°
LIGHT SOURCE	POWER LED
POWER	MAX 4W
SUPPLY	8-32 Vdc
PROTECTION	FUSE - POLARITY REVERSE SPIKE FILTER
DIMMABLE	YES
BEAM	WIDE
SCREEN	LENS
LED COLOUR	3000K CRI >90 LMN 249lm 1mt 120lx 2mt 30lx 3mt 13lx
IP RATE	IP40
MATERIALS	BODY: STAINLESS STEEL AISI 316 HEATSINK: SPECIAL COMPOUND
MOUNTING SYSTEM	(A) SPRINGS (C) SCREWS
OPTIONAL SWITCH ON THE FRAME	AVAILABLE
LED COLOUR	2700K - 4000K - (3000K+RED)
IP RATE	IP66

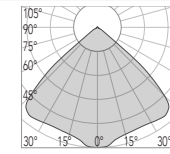

INNER CONE MADE FROM RECYCLED PLASTIC DERIVED FROM RECLAIMED SEA FISHING NETS

phoenix ag . 95



FINISHES	FE=R	23	20	4	34
	I	23			

switch on the frame





# seattle ag

. 55

. 70

. 80

. 90

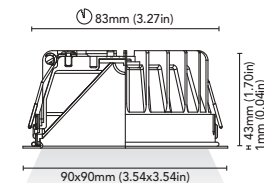
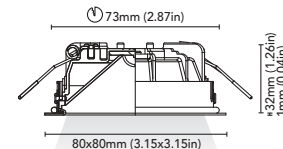
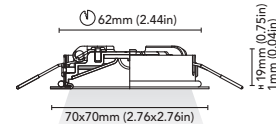
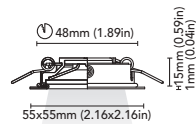

CODE	<b>3523-55A-B1.5W</b>
FIXTURE	FIXED DOWNLIGHT
ADJUSTABILITY	NO
LIGHT SOURCE	POWER LED
POWER	MAX 1,5W
SUPPLY	8-32 Vdc
PROTECTION	FUSE - POLARITY REVERSE SPIKE FILTER
DIMMABLE	YES
BEAM	WIDE
SCREEN	LENS
LED COLOUR	3000K CRI >90 LMN 87lm 1mt 63lx 2mt 16lx 3mt 7lx
IP RATE	IP40
MATERIALS	BODY: STAINLESS STEEL AISI 316 HEATSINK: SPECIAL COMPOUND
MOUNTING SYSTEM	SPRINGS
OPTIONAL	
LED COLOUR	2700K - 4000K - RED - BLUE
IP RATE	IP66

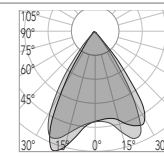

CODE	<b>3523-70A-B2W</b>
FIXTURE	FIXED DOWNLIGHT
ADJUSTABILITY	NO
LIGHT SOURCE	POWER LED
POWER	MAX 2W
SUPPLY	8-32 Vdc
PROTECTION	FUSE - POLARITY REVERSE SPIKE FILTER
DIMMABLE	YES
BEAM	WIDE
SCREEN	LENS
LED COLOUR	3000K CRI >90 LMN 196lm 1mt 63lx 2mt 16lx 3mt 7lx
IP RATE	IP40
MATERIALS	BODY: STAINLESS STEEL AISI 316 HEATSINK: SPECIAL COMPOUND
MOUNTING SYSTEM	SPRINGS
OPTIONAL	
LED COLOUR	2700K - 4000K - (3000K+RED)
IP RATE	IP66

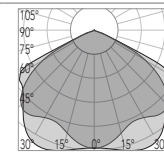

CODE	<b>3523-80A-B4W</b>
FIXTURE	FIXED DOWNLIGHT
ADJUSTABILITY	NO
LIGHT SOURCE	POWER LED
POWER	MAX 4W
SUPPLY	8-32 Vdc
PROTECTION	FUSE - POLARITY REVERSE SPIKE FILTER
DIMMABLE	YES
BEAM	WIDE
SCREEN	LENS
LED COLOUR	3000K CRI >90 LMN 249lm 1mt 120lx 2mt 30lx 3mt 13lx
IP RATE	IP40
MATERIALS	BODY: STAINLESS STEEL AISI 316 HEATSINK: SPECIAL COMPOUND
MOUNTING SYSTEM	SPRINGS
OPTIONAL	
LED COLOUR	2700K - 4000K - (3000K+RED)
IP RATE	IP66

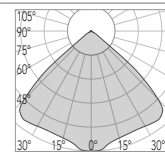

CODE	<b>3523-90A-B6W</b>
FIXTURE	FIXED DOWNLIGHT
ADJUSTABILITY	NO
LIGHT SOURCE	POWER LED
POWER	MAX 6W
SUPPLY	8-32 Vdc
PROTECTION	FUSE - POLARITY REVERSE SPIKE FILTER
DIMMABLE	YES
BEAM	WIDE
SCREEN	LENS
LED COLOUR	3000K CRI >90 LMN 286lm 1mt 165lx 2mt 41lx 3mt 18lx
IP RATE	IP40
MATERIALS	BODY: STAINLESS STEEL AISI 316 HEATSINK: SPECIAL COMPOUND
MOUNTING SYSTEM	SPRINGS
OPTIONAL	
LED COLOUR	2700K - 4000K - (3000K+RED)
IP RATE	IP66

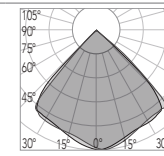

INNER CONE MADE FROM RECYCLED PLASTIC DERIVED FROM RECLAIMED SEA FISHING NETS

seattle ag . 70

FINISHES	FE	23 20 4 34
	I	23



# atlanta ag

. 80

. 90

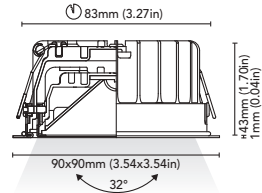
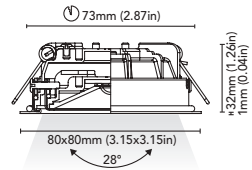

<b>CODE</b>	<b>3527-80A-B2W</b>
<b>FIXTURE</b>	ADJUSTABLE DOWNLIGHT
<b>ADJUSTABILITY</b>	△ 28°
<b>LIGHT SOURCE</b>	POWER LED
<b>POWER</b>	MAX 2W
<b>SUPPLY</b>	8-32 Vdc
<b>PROTECTION</b>	FUSE - POLARITY REVERSE SPIKE FILTER
<b>DIMMABLE</b>	YES
<b>BEAM</b>	WIDE
<b>SCREEN</b>	LENS
<b>LED COLOUR</b>	3000K CRI >90 LMN 196lm 1mt 63lx 2mt 16lx 3mt 7lx
<b>IP RATE</b>	IP40
<b>MATERIALS</b>	BODY: STAINLESS STEEL AISI 316 HEATSINK: SPECIAL COMPOUND
<b>MOUNTING SYSTEM</b>	SPRINGS
<b>OPTIONAL</b>	
<b>LED COLOUR</b>	2700K - 4000K - (3000K+RED)
<b>IP RATE</b>	IP66

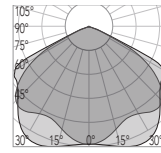

<b>CODE</b>	<b>3527-90A-B4W</b>
<b>FIXTURE</b>	ADJUSTABLE DOWNLIGHT
<b>ADJUSTABILITY</b>	△ 32°
<b>LIGHT SOURCE</b>	POWER LED
<b>POWER</b>	MAX 4W
<b>SUPPLY</b>	8-32 Vdc
<b>PROTECTION</b>	FUSE - POLARITY REVERSE SPIKE FILTER
<b>DIMMABLE</b>	YES
<b>BEAM</b>	WIDE
<b>SCREEN</b>	LENS
<b>LED COLOUR</b>	3000K CRI >90 LMN 249lm 1mt 120lx 2mt 30lx 3mt 13lx
<b>IP RATE</b>	IP40
<b>MATERIALS</b>	BODY: STAINLESS STEEL AISI 316 HEATSINK: SPECIAL COMPOUND
<b>MOUNTING SYSTEM</b>	SPRINGS
<b>OPTIONAL</b>	
<b>LED COLOUR</b>	2700K - 4000K - (3000K+RED)
<b>IP RATE</b>	IP66

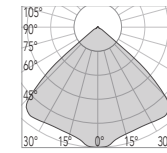

INNER CONE MADE FROM RECYCLED PLASTIC DERIVED FROM RECLAIMED SEA FISHING NETS

atlanta ag . 80

	<b>FINISHES</b>	<b>FE=R</b>	23	20	4	34
		<b>I</b>	23			



# charlotte ag

. 55

. 70

. 80

. 90 ag

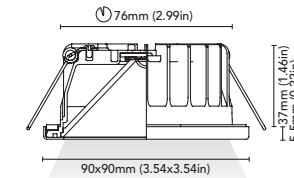
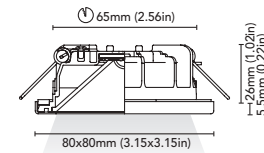
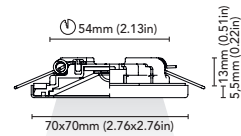
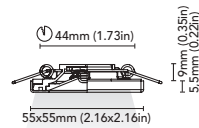

CODE	<b>3522-55A-B1.5W</b> <b>3522-55C-B1.5W</b>
FIXTURE	FIXED DOWNLIGHT
ADJUSTABILITY	NO
LIGHT SOURCE	POWER LED
POWER	MAX 1,5W
SUPPLY	8-32 Vdc
PROTECTION	FUSE - POLARITY REVERSE SPIKE FILTER
DIMMABLE	YES
BEAM	WIDE
SCREEN	LENS
LED COLOUR	3000K CRI >90 LMN 87lm 1mt 63lx 2mt 16lx 3mt 7lx
IP RATE	IP40
MATERIALS	BODY: STAINLESS STEEL AISI 316 HEATSINK: SPECIAL COMPOUND
MOUNTING SYSTEM	(A) SPRINGS (C) SCREWS
OPTIONAL SWITCH ON THE FRAME	
LED COLOUR	2700K - 4000K - RED - BLUE
IP RATE	IP66

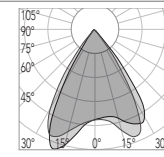

CODE	<b>3522-70A-B2W</b> <b>3522-70C-B2W</b>
FIXTURE	FIXED DOWNLIGHT
ADJUSTABILITY	NO
LIGHT SOURCE	POWER LED
POWER	MAX 2W
SUPPLY	8-32 Vdc
PROTECTION	FUSE - POLARITY REVERSE SPIKE FILTER
DIMMABLE	YES
BEAM	WIDE
SCREEN	LENS
LED COLOUR	3000K CRI >90 LMN 196lm 1mt 63lx 2mt 16lx 3mt 7lx
IP RATE	IP40
MATERIALS	BODY: STAINLESS STEEL AISI 316 HEATSINK: SPECIAL COMPOUND
MOUNTING SYSTEM	(A) SPRINGS (C) SCREWS
OPTIONAL SWITCH ON THE FRAME	AVAILABLE
LED COLOUR	2700K - 4000K - (3000K+RED)
IP RATE	IP66

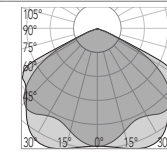

CODE	<b>3522-80A-B4W</b> <b>3522-80C-B4W</b>
FIXTURE	FIXED DOWNLIGHT
ADJUSTABILITY	NO
LIGHT SOURCE	POWER LED
POWER	MAX 4W
SUPPLY	8-32 Vdc
PROTECTION	FUSE - POLARITY REVERSE SPIKE FILTER
DIMMABLE	YES
BEAM	WIDE
SCREEN	LENS
LED COLOUR	3000K CRI >90 LMN 249lm 1mt 120lx 2mt 30lx 3mt 13lx
IP RATE	IP40
MATERIALS	BODY: STAINLESS STEEL AISI 316 HEATSINK: SPECIAL COMPOUND
MOUNTING SYSTEM	(A) SPRINGS (C) SCREWS
OPTIONAL SWITCH ON THE FRAME	AVAILABLE
LED COLOUR	2700K - 4000K - (3000K+RED)
IP RATE	IP66

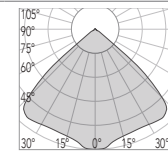

CODE	<b>3522-90A-B6W</b> <b>3522-90C-B6W</b>
FIXTURE	FIXED DOWNLIGHT
ADJUSTABILITY	NO
LIGHT SOURCE	POWER LED
POWER	MAX 6W
SUPPLY	8-32 Vdc
PROTECTION	FUSE - POLARITY REVERSE SPIKE FILTER
DIMMABLE	YES
BEAM	WIDE
SCREEN	LENS
LED COLOUR	3000K CRI >90 LMN 286lm 1mt 165lx 2mt 41lx 3mt 18lx
IP RATE	IP40
MATERIALS	BODY: STAINLESS STEEL AISI 316 HEATSINK: SPECIAL COMPOUND
MOUNTING SYSTEM	(A) SPRINGS (C) SCREWS
OPTIONAL SWITCH ON THE FRAME	AVAILABLE
LED COLOUR	2700K - 4000K - (3000K+RED)
IP RATE	IP66

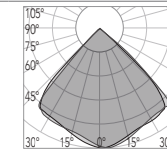

INNER CONE MADE FROM RECYCLED PLASTIC DERIVED FROM RECLAIMED SEA FISHING NETS

charlotte ag . 80



FINISHES	FE	23 20 4 34
	I	23

switch on the frame





# daytona ag

. 80

. 90

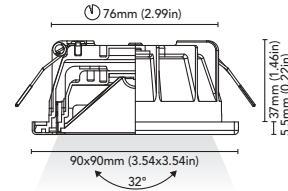
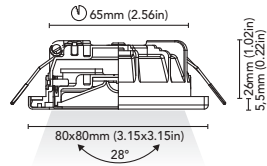

CODE	<b>3526-80A-B2W</b> <b>3526-80C-B2W</b>
FIXTURE	ADJUSTABLE DOWNLIGHT
ADJUSTABILITY	△ 28°
LIGHT SOURCE	POWER LED
POWER	MAX 2W
SUPPLY	8-32 Vdc
PROTECTION	FUSE - POLARITY REVERSE SPIKE FILTER
DIMMABLE	YES
BEAM	WIDE
SCREEN	LENS
LED COLOUR	3000K CRI >90 LMN 196lm 1mt 63lx 2mt 16lx 3mt 7lx
IP RATE	IP40
MATERIALS	BODY: STAINLESS STEEL AISI 316 HEATSINK: SPECIAL COMPOUND
MOUNTING SYSTEM	(A) SPRINGS (C) SCREWS
OPTIONAL SWITCH ON THE FRAME	AVAILABLE
LED COLOUR	2700K - 4000K - (3000K+RED)
IP RATE	IP66

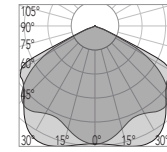

CODE	<b>3526-90A-B4W</b> <b>3526-90C-B4W</b>
FIXTURE	ADJUSTABLE DOWNLIGHT
ADJUSTABILITY	△ 32°
LIGHT SOURCE	POWER LED
POWER	MAX 4W
SUPPLY	8-32 Vdc
PROTECTION	FUSE - POLARITY REVERSE SPIKE FILTER
DIMMABLE	YES
BEAM	WIDE
SCREEN	LENS
LED COLOUR	3000K CRI >90 LMN 249lm 1mt 120lx 2mt 30lx 3mt 13lx
IP RATE	IP40
MATERIALS	BODY: STAINLESS STEEL AISI 316 HEATSINK: SPECIAL COMPOUND
MOUNTING SYSTEM	(A) SPRINGS (C) SCREWS
OPTIONAL SWITCH ON THE FRAME	AVAILABLE
LED COLOUR	2700K - 4000K - (3000K+RED)
IP RATE	IP66

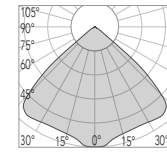

INNER CONE MADE FROM RECYCLED PLASTIC DERIVED FROM RECLAIMED SEA FISHING NETS

daytona ag . 90

	FINISHES	FE=R	23 20 4 34
		I	23

switch on the frame





# alabama ag

. 60

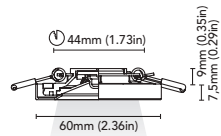

. 75

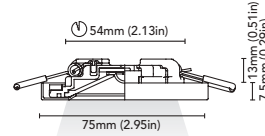

. 85

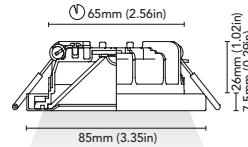

. 95

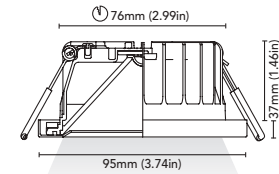

<b>CODE</b>	<b>3519-60A-B1.5W</b> <b>3519-60C-B1.5W</b>
<b>FIXTURE</b>	FIXED DOWNLIGHT
<b>ADJUSTABILITY</b>	NO
<b>LIGHT SOURCE</b>	POWER LED
<b>POWER</b>	MAX 1,5W
<b>SUPPLY</b>	8-32 Vdc
<b>PROTECTION</b>	FUSE - POLARITY REVERSE SPIKE FILTER
<b>DIMMABLE</b>	YES
<b>BEAM</b>	WIDE
<b>SCREEN</b>	LENS
<b>LED COLOUR</b>	3000K CRI >90 LMN 87lm 1mt 63lx 2mt 16lx 3mt 7lx
<b>IP RATE</b>	IP40
<b>MATERIALS</b>	BODY: STAINLESS STEEL AISI 316 HEATSINK: SPECIAL COMPOUND
<b>MOUNTING SYSTEM</b>	(A) SPRINGS (C) SCREWS
<b>OPTIONAL</b>	
<b>LED COLOUR</b>	2700K - 4000K - RED - BLUE
<b>IP RATE</b>	IP66

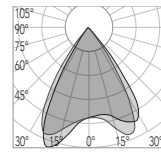

<b>CODE</b>	<b>3519-75A-B2W</b> <b>3519-75C-B2W</b>
<b>FIXTURE</b>	FIXED DOWNLIGHT
<b>ADJUSTABILITY</b>	NO
<b>LIGHT SOURCE</b>	POWER LED
<b>POWER</b>	MAX 2W
<b>SUPPLY</b>	8-32 Vdc
<b>PROTECTION</b>	FUSE - POLARITY REVERSE SPIKE FILTER
<b>DIMMABLE</b>	YES
<b>BEAM</b>	WIDE
<b>SCREEN</b>	LENS
<b>LED COLOUR</b>	3000K CRI >90 LMN 196lm 1mt 63lx 2mt 16lx 3mt 7lx
<b>IP RATE</b>	IP40
<b>MATERIALS</b>	BODY: STAINLESS STEEL AISI 316 HEATSINK: SPECIAL COMPOUND
<b>MOUNTING SYSTEM</b>	(A) SPRINGS (C) SCREWS
<b>OPTIONAL</b>	
<b>LED COLOUR</b>	2700K - 4000K - (3000K+RED)
<b>IP RATE</b>	IP66

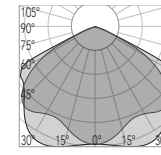

<b>CODE</b>	<b>3519-85A-B4W</b> <b>3519-85C-B4W</b>
<b>FIXTURE</b>	FIXED DOWNLIGHT
<b>ADJUSTABILITY</b>	NO
<b>LIGHT SOURCE</b>	POWER LED
<b>POWER</b>	MAX 4W
<b>SUPPLY</b>	8-32 Vdc
<b>PROTECTION</b>	FUSE - POLARITY REVERSE SPIKE FILTER
<b>DIMMABLE</b>	YES
<b>BEAM</b>	WIDE
<b>SCREEN</b>	LENS
<b>LED COLOUR</b>	3000K CRI >90 LMN 249lm 1mt 120lx 2mt 30lx 3mt 13lx
<b>IP RATE</b>	IP40
<b>MATERIALS</b>	BODY: STAINLESS STEEL AISI 316 HEATSINK: SPECIAL COMPOUND
<b>MOUNTING SYSTEM</b>	(A) SPRINGS (C) SCREWS
<b>OPTIONAL</b>	
<b>LED COLOUR</b>	2700K - 4000K - (3000K+RED)
<b>IP RATE</b>	IP66

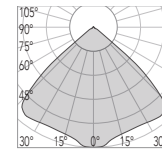

<b>CODE</b>	<b>3519-95A-B6W</b> <b>3519-95C-B6W</b>
<b>FIXTURE</b>	FIXED DOWNLIGHT
<b>ADJUSTABILITY</b>	NO
<b>LIGHT SOURCE</b>	POWER LED
<b>POWER</b>	MAX 6W
<b>SUPPLY</b>	8-32 Vdc
<b>PROTECTION</b>	FUSE - POLARITY REVERSE SPIKE FILTER
<b>DIMMABLE</b>	YES
<b>BEAM</b>	WIDE
<b>SCREEN</b>	LENS
<b>LED COLOUR</b>	3000K CRI >90 LMN 286lm 1mt 165lx 2mt 41lx 3mt 18lx
<b>IP RATE</b>	IP40
<b>MATERIALS</b>	BODY: STAINLESS STEEL AISI 316 HEATSINK: SPECIAL COMPOUND
<b>MOUNTING SYSTEM</b>	(A) SPRINGS (C) SCREWS
<b>OPTIONAL</b>	
<b>LED COLOUR</b>	2700K - 4000K - (3000K+RED)
<b>IP RATE</b>	IP66

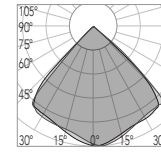

INNER CONE MADE FROM RECYCLED PLASTIC DERIVED FROM RECLAIMED SEA FISHING NETS

alabama ag . 75

	<b>FINISHES</b>	<b>FE</b>	23 20 4 34
		<b>I</b>	23



# tampa ag

. 40

# sarasota ag

. 40

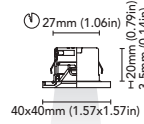
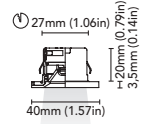

CODE	<b>3528-40-Z1.5W</b>
FIXTURE	FIXED DOWNLIGHT
ADJUSTABILITY	NO
LIGHT SOURCE	POWER LED
POWER	MAX 1,5W
SUPPLY	8-32 Vdc
PROTECTION	FUSE - POLARITY REVERSE SPIKE FILTER
DIMMABLE	YES
BEAM	WIDE
SCREEN	LENS
LED COLOUR	3000K CRI >90 LMN 73lm 1mt 49lx 2mt 12lx 3mt 5lx
IP RATE	IP66
MATERIALS	BODY: STAINLESS STEEL AISI 316 HEATSINK: SPECIAL COMPOUND
MOUNTING SYSTEM	SPRINGS
OPTIONAL LED COLOUR	2700K - 4000K - RED - BLUE

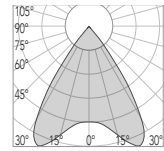

CODE	<b>3529-40-Z1.5W</b>
FIXTURE	FIXED DOWNLIGHT
ADJUSTABILITY	NO
LIGHT SOURCE	POWER LED
POWER	MAX 1,5W
SUPPLY	8-32 Vdc
PROTECTION	FUSE - POLARITY REVERSE SPIKE FILTER
DIMMABLE	YES
BEAM	WIDE
SCREEN	LENS
LED COLOUR	3000K CRI >90 LMN 73lm 1mt 49lx 2mt 12lx 3mt 5lx
IP RATE	IP66
MATERIALS	BODY: STAINLESS STEEL AISI 316 HEATSINK: SPECIAL COMPOUND
MOUNTING SYSTEM	SPRINGS
OPTIONAL LED COLOUR	2700K - 4000K - RED - BLUE

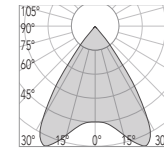

tampa ag



sarasota ag

INNER CONE MADE FROM RECYCLED PLASTIC DERIVED FROM RECLAIMED SEA FISHING NETS

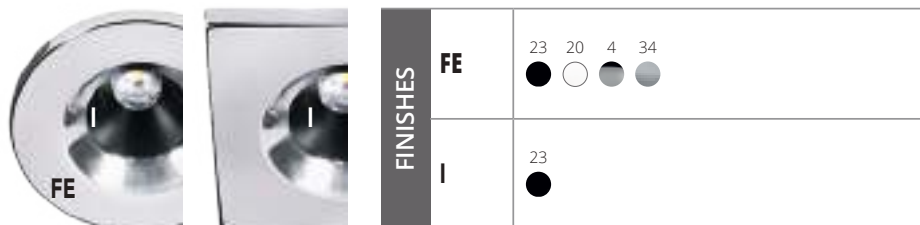



# black

## . 1010

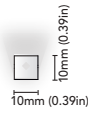

## . 1220

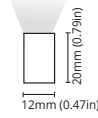

## . 1616

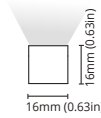

CODE	<b>5418-1MT-10WM</b> <b>5418-2MT-10WM</b> <b>5418-3MT-10WM</b> <b>5418-4MT-10WM</b> <b>5418-5MT-10WM</b>
FIXTURE	FLEXIBLE LED
BENDING	TOP
LIGHT SOURCE	LED
POWER	10W/MT
SUPPLY	24 Vdc
PROTECTION	POLARITY REVERSE
DIMMABLE	YES
BEAM	WIDE
SCREEN	BLACK
LED COLOUR	3000K CRI >90 LMN 39.6lm 1mt 19lx 2mt 5lx 3mt 2lx
IP RATE	IP67
MATERIALS	SILICONE
MOUNTING SYSTEM	NR 5 CLIPS/MT
OPTIONAL LED COLOUR	2700K - 4000K

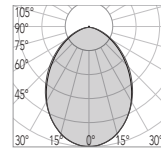

<b>5417-1MT-10WM</b> <b>5417-2MT-10WM</b> <b>5417-3MT-10WM</b> <b>5417-4MT-10WM</b> <b>5417-5MT-10WM</b>
FLEXIBLE LED
SIDE
LED
10W/MT
24 Vdc
POLARITY REVERSE
YES
WIDE
BLACK
3000K CRI >90 LMN 15.1lm 1mt 8lx 2mt 12lx 3mt 1lx
IP67
SILICONE
NR 5 CLIPS/MT
2700K - 4000K

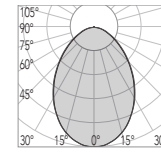

<b>5416-1MT-10WM</b> <b>5416-2MT-10WM</b> <b>5416-3MT-10WM</b> <b>5416-4MT-10WM</b> <b>5416-5MT-10WM</b>
FLEXIBLE LED
TOP
LED
10W/MT
24 Vdc
POLARITY REVERSE
YES
WIDE
BLACK
3000K CRI >90 LMN 27.1lm 1mt 13lx 2mt 3lx 3mt 1lx
IP67
SILICONE
NR 5 CLIPS/MT
2700K - 4000K

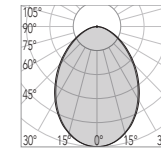

# blade three black

## three . A

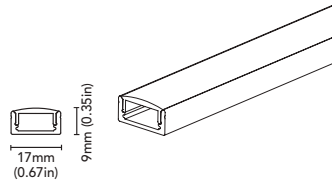

## three . B

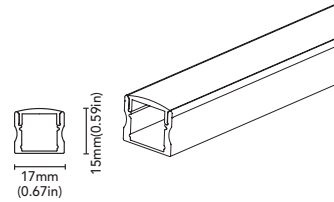

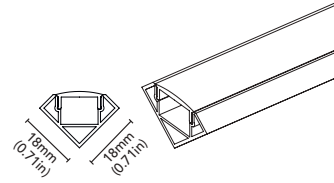

## three . C



CODE	<b>5070-P02-23</b>
FIXTURE	PROFILE
SCREEN	SMOKED
MATERIALS	BODY: BLACK ANODIZED ALUMINIUM
MOUNTING SYSTEM	CLIPS
ACCESSORIES	
CAPS 2X	5070-PEC02-23 
METAL CLIP	5070-MC02-23 

CODE	<b>5070-P04-23</b>
FIXTURE	PROFILE
SCREEN	SMOKED
MATERIALS	BODY: BLACK ANODIZED ALUMINIUM
MOUNTING SYSTEM	CLIPS
ACCESSORIES	
CAPS 2X	5070-PEC04-23 
METAL CLIP	5070-MC04-23 

CODE	<b>5070-P09-23</b>
FIXTURE	PROFILE
SCREEN	SMOKED
MATERIALS	BODY: BLACK ANODIZED ALUMINIUM
MOUNTING SYSTEM	CLIPS
ACCESSORIES	
CAPS 2X	5070-PEC09-23 
METAL CLIP	5070-MC09-23 

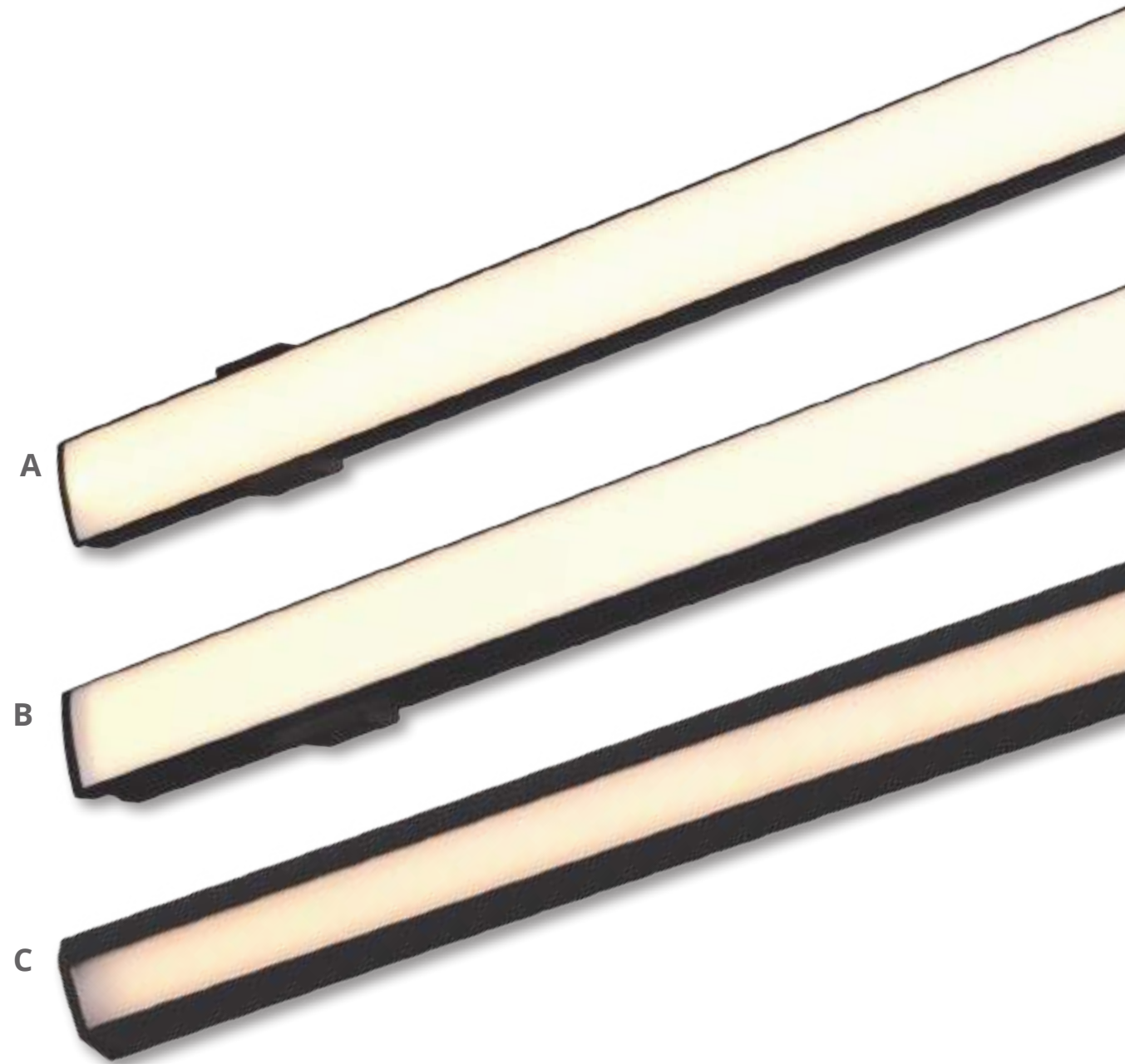

blade three black

# mini blade black

one . A

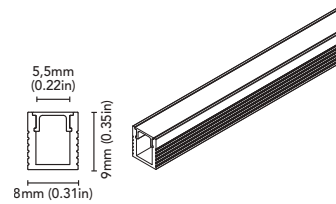

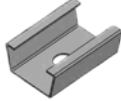
<b>CODE</b>	<b>5070-P06-23</b>
<b>FIXTURE</b>	PROFILE
<b>SCREEN</b>	SMOKED
<b>MATERIALS</b>	BODY: BLACK ANODIZED ALUMINIUM
<b>MOUNTING SYSTEM</b>	CLIPS
<b>ACCESSORIES</b>	
<b>CAPS 2X</b>	5070-PEC06-23 
<b>METAL CLIP</b>	5070-MC06-23 



mini blade black



# Track system



# tym track 4

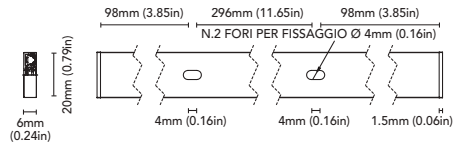

CODE	<b>5470-T4B2MT</b>
FIXTURE	ELECTRIFIED TRACK (INTERNAL POWER SUPPLY CONNECTOR NOT INCLUDED)
SUPPLY	24 Vdc
IP RATE	IP20
MATERIALS	ALUMINIUM
MOUNTING SYSTEM	SCREWS

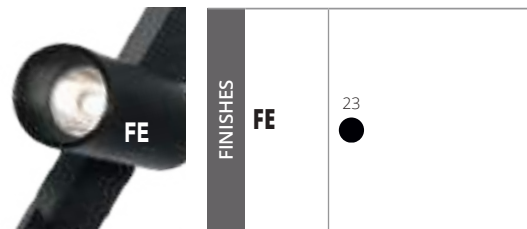

tym track 4



# tym track 5

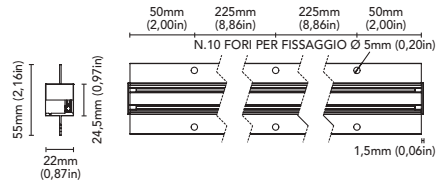

CODE	<b>5470-T5B2MT</b>
FIXTURE	ELECTRIFIED TRACK (INTERNAL POWER SUPPLY CONNECTOR NOT INCLUDED)
SUPPLY	24 Vdc
IP RATE	IP20
MATERIALS	ALUMINIUM
MOUNTING SYSTEM	SCREWS



tym track 5

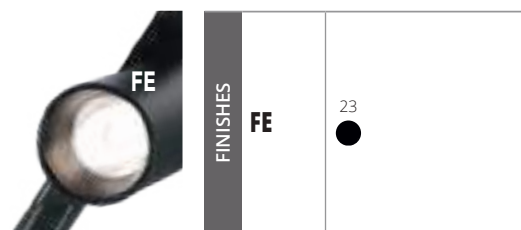

FINISHES	FE	23
----------	----	----



# tym glow

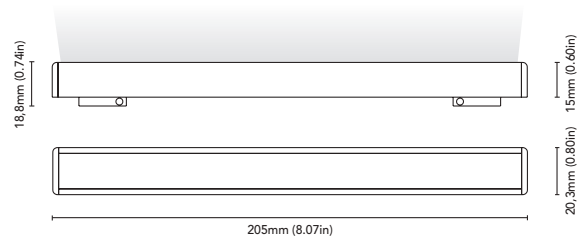

<b>CODE</b>	<b>5471-204-B6W</b>
<b>FIXTURE</b>	LINEAR LIGHT ELEMENT
<b>ADJUSTABILITY</b>	NO
<b>LIGHT SOURCE</b>	POWER LED
<b>POWER</b>	MAX 6W
<b>SUPPLY</b>	24 Vdc
<b>DIMMABLE</b>	YES
<b>BEAM</b>	WIDE
<b>SCREEN</b>	OPAL
<b>LED COLOUR</b>	3000K CRI >90 LMN 413lm 1mt 159lx 2mt 40lx 3mt 18lx
<b>IP RATE</b>	IP40
<b>MATERIALS</b>	ALUMINIUM
<b>MOUNTING SYSTEM</b>	CONNECTED ON TYM TRACK 4-5

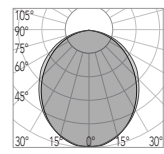

tym glow



<b>FINISHES</b>	<b>FE</b>	23
-----------------	-----------	----



# tym ray

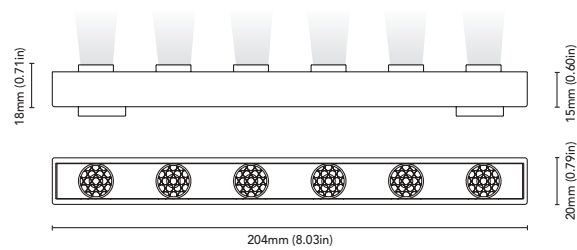

<b>CODE</b>	<b>5471-204-Z6W</b>
<b>FIXTURE</b>	LINEAR LIGHT ELEMENT
<b>ADJUSTABILITY</b>	NO
<b>LIGHT SOURCE</b>	POWER LED
<b>POWER</b>	MAX 6W
<b>SUPPLY</b>	24 Vdc
<b>DIMMABLE</b>	YES
<b>BEAM</b>	MEDIUM
<b>SCREEN</b>	LENS
<b>LED COLOUR</b>	3000K CRI >90 LMN 452lm 1mt 1236lx 2mt 309lx 3mt 137lx
<b>IP RATE</b>	IP40
<b>MATERIALS</b>	ALUMINIUM
<b>MOUNTING SYSTEM</b>	CONNECTED ON TYM TRACK 4-5

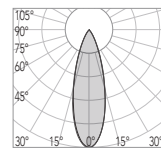

tym ray



<b>FINISHES</b>	<b>FE</b>	23 ●
-----------------	-----------	------



# tym dart

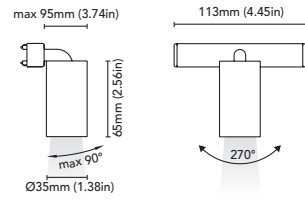

CODE	<b>5472-110-Z5W</b>
FIXTURE	SPOTLIGHT ELEMENT
ADJUSTABILITY	YES
LIGHT SOURCE	POWER LED
POWER	MAX 5W
SUPPLY	24 Vdc
DIMMABLE	YES
BEAM	MEDIUM
SCREEN	LENS
LED COLOUR	3000K CRI >90 LMN 374lm 1mt 1232lx 2mt 308lx 3mt 137lx
IP RATE	IP40
MATERIALS	ALUMINIUM
MOUNTING SYSTEM	CONNECTED ON TYM TRACK 4-5

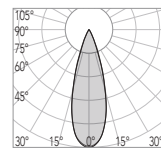

tym dart



FINISHES	<b>FE</b>	23
----------	-----------	----



# tym glow 2

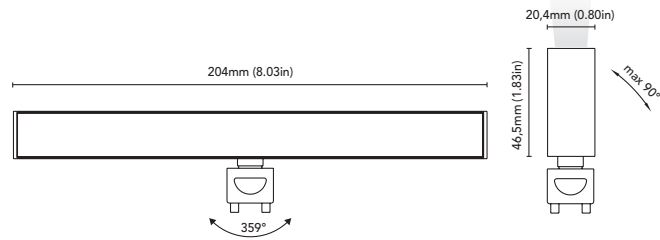

CODE	<b>5473-204-B6W</b>
FIXTURE	LINEAR LIGHT ELEMENT
ADJUSTABILITY	YES
LIGHT SOURCE	POWER LED
POWER	MAX 6W
SUPPLY	24 Vdc
DIMMABLE	YES
BEAM	WIDE
SCREEN	OPAL
LED COLOUR	3000K CRI >90 LMN 352lm 1mt 148lx 2mt 37lx 3mt 16lx
IP RATE	IP40
MATERIALS	ALUMINIUM
MOUNTING SYSTEM	CONNECTED ON TYM TRACK 4-5

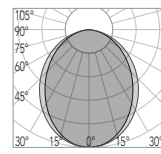

tym glow 2

	FINISHES	<b>FE</b>	23
--	----------	-----------	----



# tym ray 2

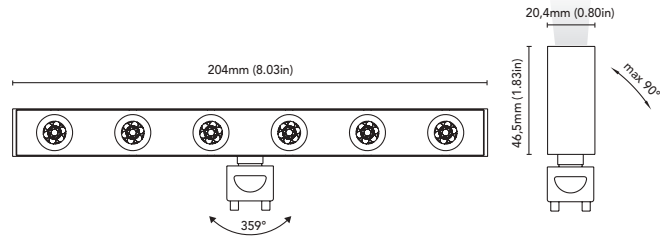

CODE	<b>5473-204-Z6W</b>
FIXTURE	LINEAR LIGHT ELEMENT
ADJUSTABILITY	YES
LIGHT SOURCE	POWER LED
POWER	MAX 6W
SUPPLY	24 Vdc
DIMMABLE	YES
BEAM	MEDIUM
SCREEN	LENS
LED COLOUR	3000K CRI >90 LMN 381lm 1mt 1262lx 2mt 315lx 3mt 140lx
IP RATE	IP40
MATERIALS	ALUMINIUM
MOUNTING SYSTEM	CONNECTED ON TYM TRACK 4-5

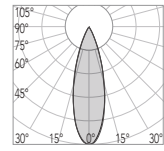

tym ray 2

	FINISHES	FE	23
--	----------	----	----

# accessories tym track 4-5

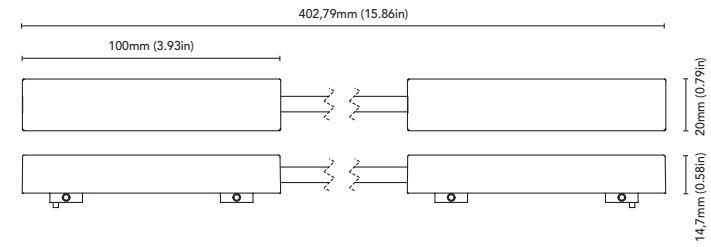
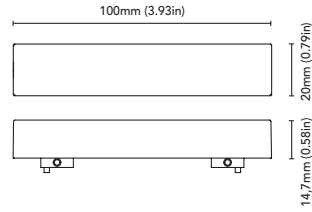
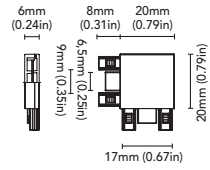
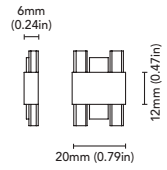

<b>CODE</b>	<b>5470-5077LT</b>
<b>FIXTURE</b>	ELECTRIFIED LINEAR CONNECTOR X TYM TRACK 4
<b>SUPPLY</b>	24 Vdc
<b>IP RATE</b>	IP 40

<b>CODE</b>	<b>5470-5077L</b>
<b>FIXTURE</b>	ELECTRIFIED ANGULAR CONNECTOR X TYM TRACK 4
<b>SUPPLY</b>	24 Vdc
<b>IP RATE</b>	IP 40

<b>CODE</b>	<b>5470-5080LT</b>
<b>FIXTURE</b>	ELECTRIFIED LINEAR CONNECTOR X TYM TRACK 5
<b>SUPPLY</b>	24 Vdc
<b>IP RATE</b>	IP 40

<b>CODE</b>	<b>5470-5080LT</b>
<b>FIXTURE</b>	ELECTRIFIED ANGULAR CONNECTOR X TYM TRACK 5
<b>SUPPLY</b>	24 Vdc
<b>IP RATE</b>	IP 40

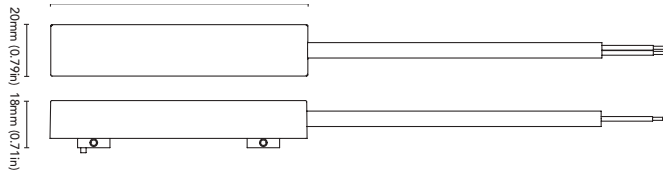
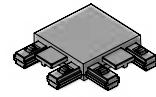
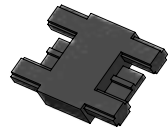

<b>CODE</b>	<b>5470-5080LDT</b>
<b>FIXTURE</b>	POWER SUPPLY CONNECTOR
<b>SUPPLY</b>	24 Vdc
<b>IP RATE</b>	IP 40

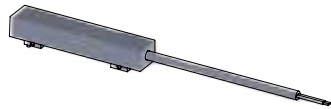



# tym track 6

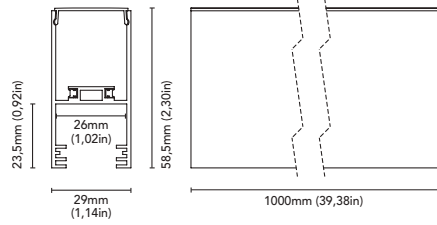

CODE	<b>5480-T6B2MT</b>
FIXTURE	ELECTRIFIED TRACK (INTERNAL POWER SUPPLY CONNECTOR NOT INCLUDED)
SUPPLY	48 Vdc
IP RATE	IP20
MATERIALS	ALUMINIUM
MOUNTING SYSTEM	SCREWS

	FINISHES	
	FE	23

tym track 6



# tym track 8

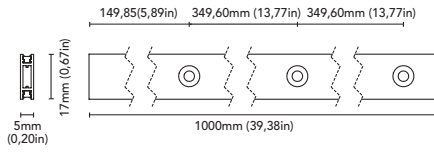

CODE	<b>5480-T8B2MT</b>
FIXTURE	ELECTRIFIED TRACK (INTERNAL POWER SUPPLY CONNECTOR NOT INCLUDED)
SUPPLY	48 Vdc
IP RATE	IP20
MATERIALS	ALUMINIUM
MOUNTING SYSTEM	SCREWS

tym track 8



FINISHES	<b>FE</b>	23
----------	-----------	----



# tym ray r

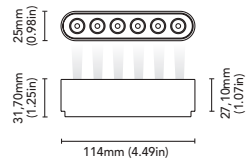

<b>CODE</b>	<b>5484-115-Z6W</b>
<b>FIXTURE</b>	LINEAR LIGHT ELEMENT
<b>ADJUSTABILITY</b>	YES
<b>LIGHT SOURCE</b>	POWER LED
<b>POWER</b>	MAX 5W
<b>SUPPLY</b>	48 Vdc
<b>DIMMABLE</b>	YES
<b>BEAM</b>	MEDIUM
<b>SCREEN</b>	LENS
<b>LED COLOUR</b>	3000K CRI >90 LMN 426lm 1mt 729lx 2mt 182lx 3mt 81lx
<b>IP RATE</b>	IP20
<b>MATERIALS</b>	ALUMINIUM
<b>MOUNTING SYSTEM</b>	CONNECTED ON TYM TRACK 6-8

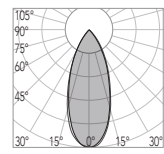

tym ray r

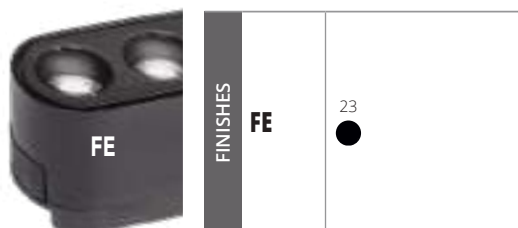



# tym glow r

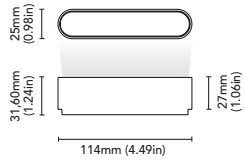

<b>CODE</b>	<b>5484-115-B6W</b>
<b>FIXTURE</b>	LINEAR LIGHT ELEMENT
<b>ADJUSTABILITY</b>	NO
<b>LIGHT SOURCE</b>	POWER LED
<b>POWER</b>	MAX 6W
<b>SUPPLY</b>	48 Vdc
<b>DIMMABLE</b>	YES
<b>BEAM</b>	WIDE
<b>SCREEN</b>	OPAL
<b>LED COLOUR</b>	3000K CRI >90 LMN 313lm 1mt 110lx 2mt 28lx 3mt 12lx
<b>IP RATE</b>	IP20
<b>MATERIALS</b>	ALUMINIUM
<b>MOUNTING SYSTEM</b>	CONNECTED ON TYM TRACK 6-8

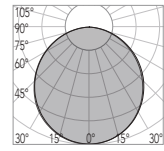

tym glow r

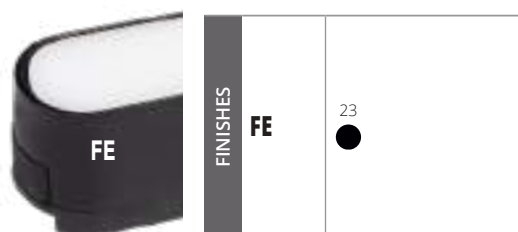



# tym ray adj

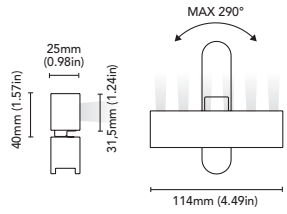

CODE	<b>5485-115-Z6W</b>
FIXTURE	LINEAR LIGHT ELEMENT
ADJUSTABILITY	YES
LIGHT SOURCE	POWER LED
POWER	MAX 6W
SUPPLY	48 Vdc
DIMMABLE	YES
BEAM	WIDE
SCREEN	LENS
LED COLOUR	3000K CRI >90 LMN 485lm 1mt 1102lx 2mt 275lx 3mt 122lx
IP RATE	IP20
MATERIALS	ALUMINIUM
MOUNTING SYSTEM	CONNECTED ON TYM TRACK 6-8

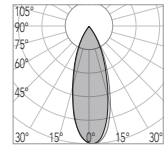

tym ray adj





# tym glow adj

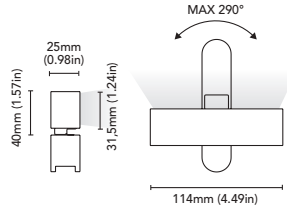

CODE	<b>5485-115-B6W</b>
FIXTURE	LINEAR LIGHT ELEMENT
ADJUSTABILITY	YES
LIGHT SOURCE	POWER LED
POWER	MAX 6W
SUPPLY	48 Vdc
DIMMABLE	YES
BEAM	WIDE
SCREEN	OPAL
LED COLOUR	3000K
	CRI >90
	LMN 313lm
	1mt 110lx
	2mt 28lx
	3mt 12lx
IP RATE	IP20
MATERIALS	ALUMINIUM
MOUNTING SYSTEM	CONNECTED ON TYM TRACK 6-8

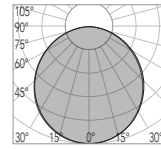

tym glow adj

FE	FINISHES	FE	23
----	----------	----	----



# tym dart r

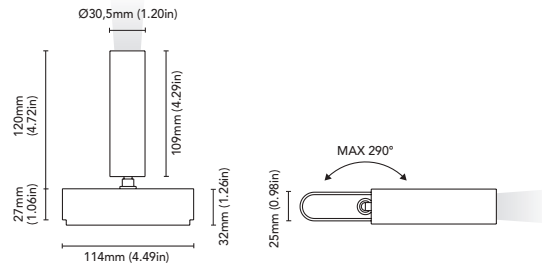

CODE	<b>5486-115-Z7W</b>
FIXTURE	SPOTLIGHT ELEMENT
ADJUSTABILITY	YES
LIGHT SOURCE	POWER LED
POWER	MAX 7W
SUPPLY	48 Vdc
DIMMABLE	YES
BEAM	WIDE
SCREEN	LENS
LED COLOUR	3000K CRI >90 LMN 537lm 1mt 1824lx 2mt 456lx 3mt 203lx
IP RATE	IP20
MATERIALS	ALUMINIUM
MOUNTING SYSTEM	CONNECTED ON TYM TRACK 6-8

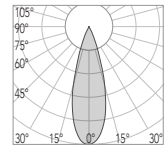

tym dart r



FINISHES

**FE**

23





# tym track 9

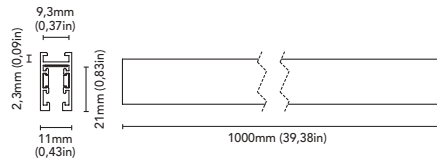

CODE	<b>5480-T9B2MT</b>
FIXTURE	ELECTRIFIED TRACK (INTERNAL POWER SUPPLY CONNECTOR NOT INCLUDED)
SUPPLY	24 Vdc
IP RATE	IP20
MATERIALS	ALUMINIUM
MOUNTING SYSTEM	SCREWS



tym track 9



FINISHES	FE	23
----------	----	----



# tym mini glow

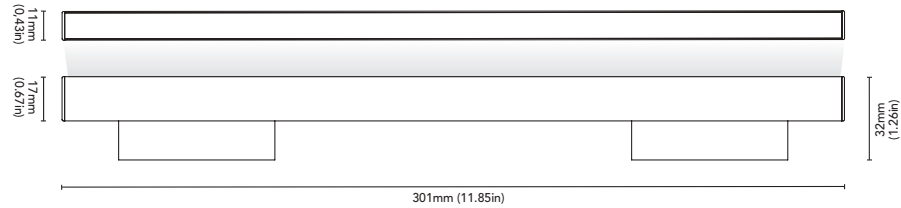

CODE	<b>5482-302-B10W</b>
FIXTURE	LINEAR LIGHT ELEMENT
ADJUSTABILITY	NO
LIGHT SOURCE	POWER LED
POWER	MAX 10W
SUPPLY	24 Vdc
DIMMABLE	YES
BEAM	WIDE
SCREEN	OPAL
LED COLOUR	3000K CRI >90 LMN 214lm 1mt 77lx 2mt 19lx 3mt 9lx
IP RATE	IP20
MATERIALS	ALUMINIUM
MOUNTING SYSTEM	CONNECTED ON TYM TRACK 9

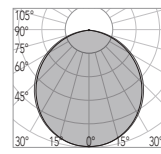

tym mini glow

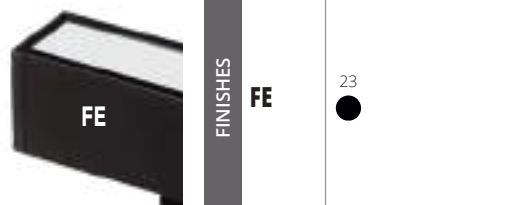



# tym mini ray

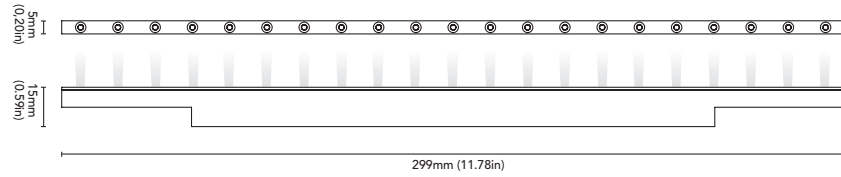

<b>CODE</b>	<b>5482-302-Z5W</b>
<b>FIXTURE</b>	LINEAR LIGHT ELEMENT
<b>ADJUSTABILITY</b>	NO
<b>LIGHT SOURCE</b>	POWER LED
<b>POWER</b>	MAX 5W
<b>SUPPLY</b>	24 Vdc
<b>DIMMABLE</b>	YES
<b>BEAM</b>	WIDE
<b>SCREEN</b>	LENS
<b>LED COLOUR</b>	3000K CRI >90 LMN 48lm 1mt 44lx 2mt 11lx 3mt 5lx
<b>IP RATE</b>	IP20
<b>MATERIALS</b>	ALUMINIUM
<b>MOUNTING SYSTEM</b>	CONNECTED ON TYM TRACK 9

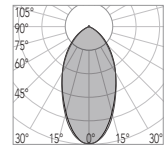

tym mini ray



<b>FINISHES</b>	<b>FE</b>	23
-----------------	-----------	----



# tym mini dart

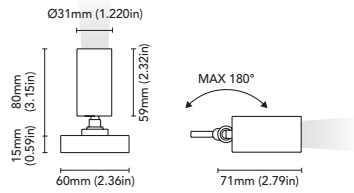

CODE	<b>5483-60-Z5W</b>
FIXTURE	SPOTLIGHT ELEMENT
ADJUSTABILITY	YES
LIGHT SOURCE	POWER LED
POWER	MAX 5W
SUPPLY	24 Vdc
DIMMABLE	YES
BEAM	MEDIUM
SCREEN	LENS
LED COLOUR	3000K CRI >90 LMN 328lm 1mt 1134lx 2mt 283lx 3mt 126lx
IP RATE	IP20
MATERIALS	ALUMINIUM
MOUNTING SYSTEM	CONNECTED ON TYM TRACK 9

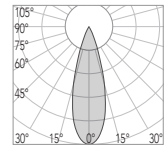

tym mini dart



FINISHES

**FE**

23



# accessories tym track 6-8-9

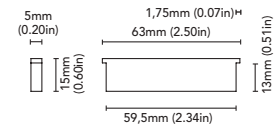
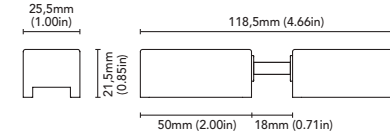
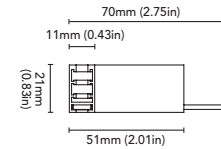
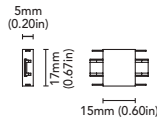
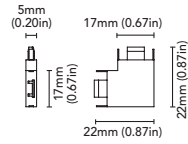
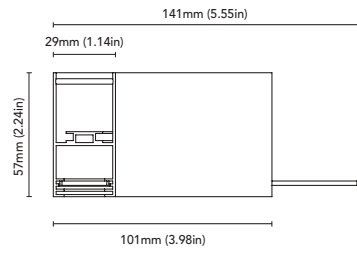

**CODE** 5480-CT6L  
**FIXTURE** ANGULAR CONNECTOR X TYM TRACK 6  
**SUPPLY** 48 Vdc



**CODE** 5480-CT8L  
**FIXTURE** ANGULAR CONNECTOR X TYM TRACK 8  
**SUPPLY** 48 Vdc

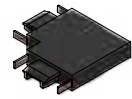

**CODE** 5480-CT8I  
**FIXTURE** LINEAR CONNECTOR X TYM TRACK 8  
**SUPPLY** 48 Vdc

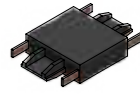

**CODE** 5480-CT9L  
**FIXTURE** ANGULAR CONNECTOR X TYM TRACK 9  
**SUPPLY** 48 Vdc



**CODE** 5480-ILINKT8  
**FIXTURE** LINEAR ELECTRIFIED CONNECTOR X TYM TRACK 6-8  
**SUPPLY** 48 Vdc

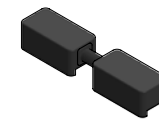

**CODE** 5480-ILINKT9  
**FIXTURE** LINEAR ELECTRIFIED CONNECTOR X TYM TRACK 9  
**SUPPLY** 48 Vdc

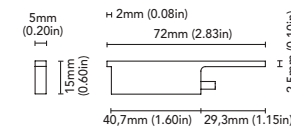
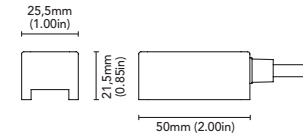
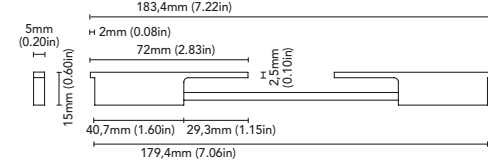
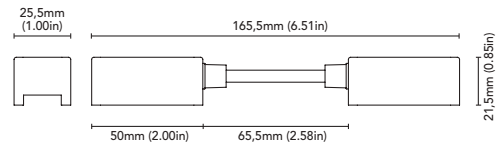
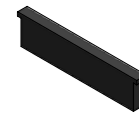

**CODE** 5480-CLINKT8  
**FIXTURE** ANGULAR ELECTRIFIED CONNECTOR X TYM TRACK 6-8  
**SUPPLY** 48 Vdc



**CODE** 5480-CLINKT9  
**FIXTURE** ANGULAR ELECTRIFIED CONNECTOR X TYM TRACK 9  
**SUPPLY** 48 Vdc



**CODE** 5480-INMODT8  
**FIXTURE** POWER SUPPLY CONNECTOR X TYM TRACK 6-8  
**SUPPLY** 48 Vdc



**CODE** 5480-INMODT9  
**FIXTURE** POWER SUPPLY CONNECTOR X TYM TRACK 9  
**SUPPLY** 48 Vdc

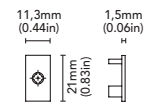
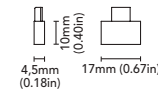
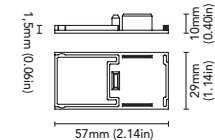
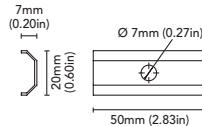
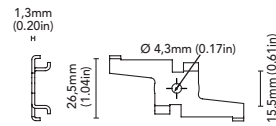
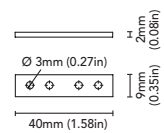
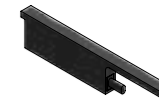

**CODE** 5480-CONPCST9  
**FIXTURE** CONNECTING BRACKET X TYM TRACK 9



**CODE** 5480-MCT6  
**FIXTURE** CLIP X TYM TRACK 6



**CODE** 5480-MCT9  
**FIXTURE** CLIP X TYM TRACK 9

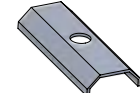

**CODE** 5480-PECT6  
**FIXTURE** ENDCAP X TYM TRACK 6

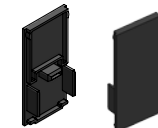

**CODE** 5480-PECT8  
**FIXTURE** ENDCAP X TYM TRACK 8

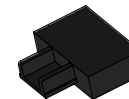

**CODE** 5480-PECT9  
**FIXTURE** ENDCAP X TYM TRACK 9



CODICE	PRODUCT	PAGE
2182-I-Z1.5W-B	Catalina I - 1,5W	86
2184-I-Z1.5W-B	Ventura I - 1,5W	88
2184U-I-Z1.5W-B	Ventura I USB - 1,5W	90
2185-I-Z1.5W-B	Arizona I - 1,5W	92
2185U-I-Z1.5W-B	Arizona I USB- 1,5W	94
2186-I-B3W-A	Philly I - 3W	96
2186U-I-B3W-A	Philly I USB- 3W	98
3405-55A-B1.5W-S	Miami 55A - 1,5W	54
3405-55C-B1.5W-S	Miami 55C - 1,5W	54
3405-70A-B2W-S	Miami 70A - 2W	54
3405-70C-B2W-S	Miami 70C - 2W	54
3405-80A-B4W-S	Miami 80A - 4W	54
3405-80C-B4W-S	Miami 80C - 4W	54
3405-90A-B6W-S	Miami 90A - 6W	54
3405-90C-B6W-S	Miami 90C - 6W	54
3406-60A-B1.5W-S	Orlando 60A - 1,5W	34
3406-60C-B1.5W-S	Orlando 60C - 1,5W	34
3406-75A-B2W-S	Orlando 75A - 2W	34
3406-75C-B2W-S	Orlando 75C - 2W	34
3406-85A-B4W-S	Orlando 85A - 4W	34
3406-85C-B4W-S	Orlando 85C - 4W	34
3406-95A-B6W-S	Orlando 95A - 6W	34
3406-95C-B6W-S	Orlando 95C - 6W	34
3407-55A-B1.5W-S	Charlotte 55A - 1,5W	46
3407-55C-B1.5W-S	Charlotte 55C - 1,5W	46
3407-70A-B2W-S	Charlotte 70A - 2W	46
3407-70C-B2W-S	Charlotte 70C - 2W	46
3407-80A-B4W-S	Charlotte 80A - 4W	46
3407-80C-B4W-S	Charlotte 80C - 4W	46
3407-90A-B6W-S	Charlotte 90A - 6W	46
3407-90C-B6W-S	Charlotte 90C - 6W	46
3408-85A-B2W-S	Phoenix 85A - 2W	36
3408-85C-B2W-S	Phoenix 85C - 2W	36
3408-95A-B4W-S	Phoenix 95A - 4W	36
3408-95C-B4W-S	Phoenix 95C - 4W	36
3409-80A-B2W-S	Daytona 80A - 2W	48
3409-80C-B2W-S	Daytona 80C - 2W	48
3409-90A-B4W-S	Daytona 90A - 4W	48

CODICE	PRODUCT	PAGE
3409-90C-B4W-S	Daytona 90C - 4W	48
3411-55A-B1.5W-S	Venice 55A - 1,5W	50
3411-70A-B2W-S	Venice 70A - 2W	50
3411-80A-B4W-S	Venice 80A - 4W	50
3411-90A-B6W-S	Venice 90A - 6W	50
3412-60A-B1.5W-S	Malibù 60A - 1,5W	26
3412-75A-B2W-S	Malibù 75A - 2W	26
3412-85A-B4W-S	Malibù 85A - 4W	26
3412-95A-B6W-S	Malibù 95A - 6W	26
3413-55A-B1.5W-S	Seattle 55A - 1,5W	38
3413-70A-B2W-S	Seattle 70A - 2W	38
3413-80A-B4W-S	Seattle 80A - 4W	38
3413-90A-B6W-S	Seattle 90A - 6W	38
3414-85A-B2W-S	Newport 85A - 2W	30
3414-95A-B4W-S	Newport 95A - 4W	30
3415-80A-B2W-S	Atlanta 80A - 2W	42
3415-90A-B4W-S	Atlanta 90A - 4W	42
3416-40-Z1.5W-S	Tampa 40 - 1,5W	72
3417-40-Z1.5W-S	Sarasota 40 - 1,5W	72
3418-77A-B2W-S	Aspen 77A - 2W	58
3418-77AS-B2W-S	Aspen 77AS - 2W	58
3418-77C-B2W-S	Aspen 77C - 2W	58
3418-77CS-B2W-S	Aspen 77CS - 2W	58
3418-87A-B4W-S	Aspen 87A - 4W	58
3418-87AS-B4W-S	Aspen 87AS - 4W	58
3418-87C-B4W-S	Aspen 87C - 4W	58
3418-87CS-B4W-S	Aspen 87CS - 4W	58
3419-77A-B2W-S	Colorado 77A - 2W	56
3419-77AS-B2W-S	Colorado 77AS - 2W	56
3419-87A-B4W-S	Colorado 87A - 4W	56
3419-87AS-B4W-S	Colorado 87AS - 4W	56
3420-40G-B1.5W-S	Florida 2L - 1,5W	74
3420-40U-B1.5W-S	Florida 1L - 1,5W	74
3421-40G-B1.5W-S	Portland 2L - 1,5W	76
3421-40U-B1.5W-S	Portland 1L - 1,5W	76
3422-60A-B1.5W-S	Alabama 60A - 1,5W	60
3422-60C-B1.5W-S	Alabama 60C - 1,5W	60
3422-75A-B2W-S	Alabama 75A - 2W	60

CODICE	PRODUCT	PAGE
3422-75C-B2W-S	Alabama 75C - 2W	60
3422-85A-B4W-S	Alabama 85A - 4W	60
3422-85C-B4W-S	Alabama 85C - 4W	60
3422-95A-B6W-S	Alabama 95A - 6W	60
3422-95C-B6W-S	Alabama 95C - 6W	60
3432-40-B1.5W-S	Savannah 40 - 1,5W	70
3450-20-1LED-S	Detroit 20 - 0,5W	82
3451-20-1LED-S	Boston 20 - 0,5W	82
3452-35-1LED-S	Columbia 35 - 0,5W	78
3453-35-1LED-S	Dana 35 - 0,5W	80
3454-35-1LED-S	Nevada 35 - 0,5W	78
3455-35-1LED-S	Baltimora 35 - 0,5W	80
3477-40G-1LED-S	Dallas 2L 40 - 0,5W	64
3477-40U-1LED-S	Dallas 1L 40 - 0,5W	64
3478-40-1LED-S	Bedford 40 - 0,5W	68
3479-105A-B8W-S	Ocean 105A - 8W	22
3479-105C-B8W-S	Ocean 105C - 8W	22
3479-130A-B10W-S	Ocean 130A - 10W	22
3479-130C-B10W-S	Ocean 130C - 10W	22
3479-155A-B12W-S	Ocean 155A - 12W	22
3479-155C-B12W-S	Ocean 155C - 12W	22
3479-210A-B18W-S	Ocean 210A - 18W	22
3479-210C-B18W-S	Ocean 210C - 18W	22
3519-60A-B1.5W-S	Alabama AG 60A - 1,5W	160
3519-60C-B1.5W-S	Alabama AG 60C - 1,5W	160
3519-75A-B2W-S	Alabama AG 75A - 2W	160
3519-75C-B2W-S	Alabama AG 75C - 2W	160
3519-85A-B4W-S	Alabama AG 85A - 4W	160
3519-85C-B4W-S	Alabama AG 85C - 4W	160
3519-95A-B6W-S	Alabama AG 95A - 6W	160
3519-95C-B6W-S	Alabama AG 95C - 6W	160
3520-60A-B1.5W-S	Orlando AG 60A - 1,5W	148
3520-60C-B1.5W-S	Orlando AG 60C - 1,5W	148
3520-75A-B2W-S	Orlando AG 75A - 2W	148
3520-75C-B2W-S	Orlando AG 75C - 2W	148
3520-85A-B4W-S	Orlando AG 85A - 4W	148
3520-85C-B4W-S	Orlando AG 85C - 4W	148
3520-95A-B6W-S	Orlando AG 95A - 6W	148

CODICE	PRODUCT	PAGE
3520-95C-B6W-S	Orlando AG 95C - 6W	148
3521-60A-B1.5W-S	Malibù AG 60A - 1,5W	144
3521-75A-B2W-S	Malibù AG 75A - 2W	144
3521-85A-B4W-S	Malibù AG 85A - 4W	144
3521-95A-B6W-S	Malibù AG 95A - 6W	144
3522-55A-B1.5W-S	Charlotte AG 55A - 1,5W	156
3522-55C-B1.5W-S	Charlotte AG 55C - 1,5W	156
3522-70A-B2W-S	Charlotte AG 70A - 2W	156
3522-70C-B2W-S	Charlotte AG 70C - 2W	156
3522-80A-B4W-S	Charlotte AG 80A - 4W	156
3522-80C-B4W-S	Charlotte AG 80C - 4W	156
3522-90A-B6W-S	Charlotte AG 90A - 6W	156
3522-90C-B6W-S	Charlotte AG 90C - 6W	156
3523-55A-B1.5W-S	Seattle AG 55A - 1,5W	152
3523-70A-B2W-S	Seattle AG 70A - 2W	152
3523-80A-B4W-S	Seattle AG 80A - 4W	152
3523-90A-B6W-S	Seattle AG 90A - 6W	152
3524-85A-B2W-S	Phoenix AG 85A - 2W	150
3524-85C-B2W-S	Phoenix AG 85C - 2W	150
3524-95A-B4W-S	Phoenix AG 95A - 4W	150
3524-95C-B4W-S	Phoenix AG 95C - 4W	150
3525-85A-B2W-S	Newport AG 85A - 2W	146
3525-95A-B4W-S	Newport AG 95A - 4W	146
3526-80A-B2W-S	Daytona AG 80A - 2W	158
3526-80C-B2W-S	Daytona AG 80C - 2W	158
3526-90A-B4W-S	Daytona AG 90A - 4W	158
3526-90C-B4W-S	Daytona AG 90C - 4W	158
3527-80A-B2W-S	Atlanta AG 80A - 2W	154
3527-90A-B4W-S	Atlanta AG 90A - 4W	154
3528-40-Z1.5W-S	Tampa AG 40 - 1,5W	162
3529-40-Z1.5W-S	Sarasota AG 40 - 1,5W	162
3536-80G-B1.5W-S	Dallas 2L 80 - 1,5W	66
3536-80U-B1.5W-S	Dallas 1L 80 - 1,5W	66
3537-80-B1.5W	Bedford 80 - 1,5W	68
3546-60A-B1.5W-S	Malibù R 60A - 1,5W	28
3546-75A-B2W-S	Malibù R 75A - 2W	28
3546-85A-B4W-S	Malibù R 85A - 4W	28
3546-95A-B6W-S	Malibù R 95A - 6W	28

CODICE	PRODUCT	PAGE
3547-85A-B2W-S	Newport R 85A - 2W	32
3547-95A-B4W-S	Newport R 95A - 4W	32
3548-55A-B1.5W-S	Venice R 55A - 1,5W	52
3548-70A-B2W-S	Venice R 70A - 2W	52
3548-80A-B4W-S	Venice R 80A - 4W	52
3548-90A-B6W-S	Venice R 90A - 6W	52
3549-55A-B1.5W-S	Seattle R 55A - 1,5W	40
3549-70A-B2W-S	Seattle R 70A - 2W	40
3549-80A-B4W-S	Seattle R 80A - 4W	40
3549-90A-B6W-S	Seattle R 90A - 6W	40
3550-80A-B2W-S	Atlanta R 80A - 2W	44
3550-90A-B4W-S	Atlanta R 90A - 4W	44
3551-50-P4.5W	Memphis 1 50 - 4,5W	20
3551-65-P6W	Memphis 1 65 - 6W	20
3552-50-P4.5W-A	Vegas 1 50 - 4,5W	16
3552-65-P6W-A	Vegas 1 65 - 6W	16
3553-65-P6W-A	Vegas 2 65 - 6W	18
5070-P01	Blade Four A	134
5070-P02	Blade Three A	132
5070-P02-23	Blade Three Black A	166
5070-P03	Blade Four B	134
5070-P04	Blade Three B	132
5070-P04-23	Blade Three Black B	166
5070-P05	Blade Three C	132
5070-P05-23	Blade Three Black C	166
5070-P06	Mini Blade One - A	126
5070-P06-23	Mini Blade Black One - A	168
5070-P07	Mini Blade Two - B	126
5070-P08	Mini Blade Three - C	126
5070-P17	Blade Two A	130
5070-P18	Blade One A	128
5070-P23	Blade Five	136
5070-P45	Blade Two B	130
5070-P46	Blade One B	128
5070-P47	Blade Two C	130
5070-P48	Blade One C	128
5337-240MV-20WM	Flex 240-Top - 20W/m	140
5337-240NV-10WM	Miniflex 240-Top - 10W/m	138

CODICE	PRODUCT	PAGE
5337-240NV-10WM	Miniflex 240IP-Top - 10W/m	138
5338-120MC-10WM	Flex 120-Top - 10W/m	140
5338-120MCP-10WM	Flex 120IP-Top - 10W/m	140
5338-60MC-5WM	Flex 60-Top - 5W/m	140
5338-60MCP-5WM	Flex 60IP-Top - 5W/m	140
5400-KIT1	Kit X IK 1617	122
5400-KIT10	Kit X Black 1220	122
5400-KIT11	Kit X Black 1616	122
5400-KIT2	Kit X Neonflex1019	122
5400-KIT3	Kit X IK 1010	122
5400-KIT4	Kit X Neonflex 0606	122
5400-KIT5	Kit X IK 0606	122
5400-KIT6	Kit X Duneflex	122
5400-KIT7	Kit X Round S-M	122
5400-KIT8	Kit X Round B	122
5400-KIT9	Kit X Black 1010	122
5400-PRO1	Plastic profile X IK 1617-1MT	120
5400-PRO10	Aluminium profile X Duneflex-1MT	120
5400-PRO10F	Flexible aluminium profile X Duneflex-1MT	120
5400-PRO10R	Recessed aluminium profile X Duneflex-1MT	120
5400-PRO1F	Flexible plastic profile X IK 1617-1MT	120
5400-PRO2	Aluminium profile X IK 1617-1MT	120
5400-PRO2F	Flexible aluminium profile X IK 1617-1MT	120
5400-PRO4	Plastic profile X Neonflex 1010-1MT	120
5400-PRO5	Plastic profile X IK 1010-1MT	120
5400-PRO5F	Flexible plastic profile X IK 1010-1MT	120
5400-PRO6	Aluminium profile X IK 1010-1MT	120
5400-PRO6F	Flexible aluminium profile X IK 1010-1MT	120
5400-PRO6MF	Flexible steel profile X IK 1010-1MT	120
5400-PRO8	Aluminium profile X Neonflex 0606-1MT	120
5400-PRO9	Aluminium profile X IK 0606-1MT	120
5400-PRO9F	Flexible aluminium profile X IK 0606-1MT	120
5404-1MT-10WM	Neonflex 1010 3View 1MT - 10W/m	116
5404-2MT-10WM	Neonflex 1010 3View 2MT - 10W/m	116
5404-3MT-10WM	Neonflex 1010 3View 3MT - 10W/m	116
5404-4MT-10WM	Neonflex 1010 3View 4MT - 10W/m	116
5404-5MT-10WM	Neonflex 1010 3View 5MT - 10W/m	116
5415-1MT-10WM	Neonflex 1010 3View fc 1MT - 10W/m	116

CODICE	PRODUCT	PAGE
5415-2MT-10WM	Neonflex 1010 3View fc 2MT - 10W/m	116
5415-3MT-10WM	Neonflex 1010 3View fc 3MT - 10W/m	116
5415-4MT-10WM	Neonflex 1010 3View fc 4MT - 10W/m	116
5415-5MT-10WM	Neonflex 1010 3View fc 5MT - 10W/m	116
5416-1MT-10WM	Black 1616 1MT - 10W/m	164
5416-2MT-10WM	Black 1616 2MT - 10W/m	164
5416-3MT-10WM	Black 1616 3MT - 10W/m	164
5416-4MT-10WM	Black 1616 4MT - 10W/m	164
5416-5MT-10WM	Black 1616 5MT - 10W/m	164
5417-4MT-10WM	Black 1220 1MT - 10W/m	164
5417-4MT-10WM	Black 1220 2MT - 10W/m	164
5417-4MT-10WM	Black 1220 3MT - 10W/m	164
5417-4MT-10WM	Black 1220 4MT - 10W/m	164
5417-4MT-10WM	Black 1220 5MT - 10W/m	164
5418-1MT-10WM	Black 1010 1MT - 10W/m	164
5418-2MT-10WM	Black 1010 2MT - 10W/m	164
5418-3MT-10WM	Black 1010 3MT - 10W/m	164
5418-4MT-10WM	Black 1010 4MT - 10W/m	164
5418-5MT-10WM	Black 1010 5MT - 10W/m	164
5421-1MT-8WM	Round Smooth S 1MT- 8W/m	112
5421-2MT-8WM	Round Smooth S 2MT- 8W/m	112
5421-3MT-8WM	Round Smooth S 3MT- 8W/m	112
5421-4MT-8WM	Round Smooth S 4MT- 8W/m	112
5421-5MT-8WM	Round Smooth S 5MT- 8W/m	112
5422-1MT-8WM	Round Knit S 1MT- 8W/m	114
5422-2MT-8WM	Round Knit S 2MT- 8W/m	114
5422-3MT-8WM	Round Knit S 3MT- 8W/m	114
5422-4MT-8WM	Round Knit S 4MT- 8W/m	114
5422-5MT-8WM	Round Knit S 5MT- 8W/m	114
5423-1MT-10WM	Round Smooth M 1MT- 10W/m	112
5423-2MT-10WM	Round Smooth M 2MT- 10W/m	112
5423-3MT-10WM	Round Smooth M 3MT- 10W/m	112
5423-4MT-10WM	Round Smooth M 4MT- 10W/m	112
5423-5MT-10WM	Round Smooth M 5MT- 10W/m	112
5424-1MT-10WM	Round Knit M 1MT-10W/m	114
5424-2MT-10WM	Round Knit M 2MT-10W/m	114
5424-3MT-10WM	Round Knit M 3MT-10W/m	114
5424-4MT-10WM	Round Knit M 4MT-10W/m	114

CODICE	PRODUCT	PAGE
5424-5MT-10WM	Round Knit M 5MT-10W/m	114
5425-1MT-10WM	Round Smooth B 1MT-10W/m	112
5425-2MT-10WM	Round Smooth B 2MT-10W/m	112
5425-3MT-10WM	Round Smooth B 3MT-10W/m	112
5425-4MT-10WM	Round Smooth B 4MT-10W/m	112
5425-5MT-10WM	Round Smooth B 5MT-10W/m	112
5426-1MT-10WM	Round Knit B 1MT-10W/m	114
5426-2MT-10WM	Round Knit B 2MT-10W/m	114
5426-3MT-10WM	Round Knit B 3MT-10W/m	114
5426-4MT-10WM	Round Knit B 4MT-10W/m	114
5426-5MT-10WM	Round Knit B 5MT-10W/m	114
5430-1MT-6WM	Neonflex 0606 Top 1MT - 6W/m	118
5430-2MT-6WM	Neonflex 0606 Top 2MT - 6W/m	118
5430-3MT-6WM	Neonflex 0606 Top 3MT - 6W/m	118
5430-4MT-6WM	Neonflex 0606 Top 4MT - 6W/m	118
5430-5MT-6WM	Neonflex 0606 Top 5MT - 6W/m	118
5431-1MT-6WM	Neonflex 0606 side 1MT - 6W/m	118
5431-2MT-6WM	Neonflex 0606 side 2MT - 6W/m	118
5431-3MT-6WM	Neonflex 0606 side 3MT - 6W/m	118
5431-4MT-6WM	Neonflex 0606 side 4MT - 6W/m	118
5431-5MT-6WM	Neonflex 0606 side 5MT - 6W/m	118
5432-1MT-6WM	IK 0606 Top 1MT - 6W/m	102
5432-2MT-6WM	IK 0606 Top 2MT - 6W/m	102
5432-3MT-6WM	IK 0606 Top 3MT - 6W/m	102
5432-4MT-6WM	IK 0606 Top 4MT - 6W/m	102
5432-5MT-6WM	IK 0606 Top 5MT - 6W/m	102
5433-1MT-6WM	IK 0606 Side 1MT - 6W/m	102
5433-2MT-6WM	IK 0606 Side 2MT - 6W/m	102
5433-3MT-6WM	IK 0606 Side 3MT - 6W/m	102
5433-4MT-6WM	IK 0606 Side 4MT - 6W/m	102
5433-5MT-6WM	IK 0606 Side 5MT - 6W/m	102
5434-1MT-10WM	IK 1010 3View 1MT- 10W/m	104
5434-2MT-10WM	IK 1010 3View 2MT- 10W/m	104
5434-3MT-10WM	IK 1010 3View 3MT- 10W/m	104
5434-4MT-10WM	IK 1010 3View 4MT- 10W/m	104
5434-5MT-10WM	IK 1010 3View 5MT- 10W/m	104
5435-1MT-10WM	IK 1010 Top 1MT - 10W/m	104
5435-2MT-10WM	IK 1010 Top 2MT - 10W/m	104

# Table of articles

CODICE	PRODUCT	PAGE
5435-3MT-10WM	IK 1010 Top 3MT - 10W/m	104
5435-4MT-10WM	IK 1010 Top 4MT - 10W/m	104
5435-5MT-10WM	IK 1010 Top 5MT - 10W/m	104
5436-1MT-10WM	IK 1010 Side 1MT- 10W/m	104
5436-2MT-10WM	IK 1010 Side 2MT- 10W/m	104
5436-3MT-10WM	IK 1010 Side 3MT- 10W/m	104
5436-4MT-10WM	IK 1010 Side 4MT- 10W/m	104
5436-5MT-10WM	IK 1010 Side 5MT- 10W/m	104
5437-1MT-10WM	IK 1617 Double Bending 1MT- 10W/m	106
5437-2MT-10WM	IK 1617 Double Bending 2MT- 10W/m	106
5437-3MT-10WM	IK 1617 Double Bending 3MT- 10W/m	106
5437-4MT-10WM	IK 1617 Double Bending 4MT- 10W/m	106
5437-5MT-10WM	IK 1617 Double Bending 5MT- 10W/m	106
5438-1MT-10WM	IK 1617 Top 1MT- 10W/m	106
5438-2MT-10WM	IK 1617 Top 2MT- 10W/m	106
5438-3MT-10WM	IK 1617 Top 3MT- 10W/m	106
5438-4MT-10WM	IK 1617 Top 4MT- 10W/m	106
5438-5MT-10WM	IK 1617 Top 5MT- 10W/m	106
5439-1MT-10WM	IK 1617 Side 1MT- 10W/m	106
5439-2MT-10WM	IK 1617 Side 2MT- 10W/m	106
5439-3MT-10WM	IK 1617 Side 3MT- 10W/m	106
5439-4MT-10WM	IK 1617 Side 4MT- 10W/m	106
5439-5MT-10WM	IK 1617 Side 5MT- 10W/m	106
5440-1MT-10WM	Duneflex 1MT - 10W/m	108
5440-2MT-10WM	Duneflex 2MT - 10W/m	108
5440-3MT-10WM	Duneflex 3MT - 10W/m	108
5440-4MT-10WM	Duneflex 4MT - 10W/m	108
5440-5MT-10WM	Duneflex 5MT - 10W/m	108
5470-5077L	Electrified angular connector X Track 4	186
5470-5077LT	Electrified linear connector X Track 4	186
5470-5080LDT	Power supply connector	186
5470-5080LT	Electrified Linear Connector X Track 5	186
5470-5080LTL	Electrified linear connector X Track 5	186
5470-T4B2MT-A	Tym Track 4	172
5470-T5B2MT-A	Tym Track 5	174
5471-204-B6W-A	Tym Glow	176
5471-204-Z6W-A	Tym Ray	178

CODICE	PRODUCT	PAGE
5472-110-Z5W	Tym Dart	180
5473-204-B6W	Tym Glow 2	182
5473-204-Z6W	Tym Ray 2	184
5480-CLINKT8	Angular electrified connector X Track 8	210
5480-CLINKT9	Angular electrified connector X Track 9	210
5480-CONPCST9	Connecting bracket X Track 9	210
5480-CT6L	Angular connector X Track 6	210
5480-CT8I	Linear connector X Track 8	210
5480-CT8L	Angular connector X Track 8	210
5480-CT9L	Angular connector X Track 9	210
5480-ILINKT8	Linear electrified connector X Track 8	210
5480-ILINKT9	Linear electrified connector X Track 9	210
5480-INMODT8	Power supply connector X Track 8	210
5480-INMODT9	Power supply connector X Track 9	210
5480-MCT6	Clip X Track 6	210
5480-MCT9	Clip X Track 9	210
5480-PECT6	Endcap X Track 6	210
5480-PECT8	Endcap X Track 8	210
5480-PECT9	Endcap X Track 9	210
5480-T6B2MT-A	Tym Track 6	188
5480-T8B2MT-A	Tym Track 8	190
5480-T9B2MT-A	Tym Track 9	202
5482-302-B10W	Tym Mini Glow	204
5482-302-Z5W-A-23	Tym Mini Ray	206
5483-60-Z5W	Tym Mini Dart	208
5484-115-B6W	Tym Glow R	194
5484-115-Z6W	Tym Ray R	192
5485-115-B6W	Tym Glow Adj	198
5485-115-Z6W	Tym Ray Adj	196
5486-115-Z7W	Tym Dart R	200
9000-RING130	Ring 130 X Ocean 105	24
9000-RING155	Ring 155 X Ocean 130	24
9000-RING180	Ring 180 X Ocean 155	24
9000-RING235	Ring 235 X Ocean 210	24

Desideriamo ringraziare tutti coloro che nella lunga storia della nostra azienda hanno contribuito con capacità, serietà e impegno a fare del marchio BCM il riferimento di eccellenza nella produzione di apparecchi per illuminazione. Un successo la cui parte integrante sono i nostri clienti, tra i più prestigiosi cantieri e designers nel settore della nautica, importanti architetti e operatori nel settore residenziale e "contract", che continuano a privilegiare la scelta dei nostri prodotti ritenendoli esempio di stile, affidabilità e sicurezza.

We wish to thank all those who in the long history of our company have contributed with ability, professionalism and commitment towards making the BCM brand a landmark of excellence in the production of lighting fixtures. Our customers, who form an integral part of our success and include the most prestigious shipyards and designers in the nautical field, as well as important architects and operators in the residential and "contract" sectors, continue to prefer our range of products for their cutting-edge style, reliability and safety.



L'azienda si riserva il diritto, in qualsiasi momento e senza preavviso, di eliminare gli articoli che riterrà opportuno e/o di apportare tutte le modifiche atte a migliorare il prodotto. Non può inoltre assumersi responsabilità per eventuali inesattezze del presente catalogo dovute ad errori di stampa, trascrizione e traduzione.

*The company reserves, at any moment and without prior notice, the right to discontinue producing or to modify whichever item with the purpose of improving quality. The company can not take the responsibility for any errors present in this catalogue due to misprint, mistakes in copying and translation.*

BCM illuminazione srl

Via G. Pastore, 2  
55041 Capezzano Pianore  
Lucca • Italia  
Tel. +39 0584 969632  
Fax +39 0584 969578

[www.bcmilluminazione.com](http://www.bcmilluminazione.com)  
[info@bcmilluminazione.com](mailto:info@bcmilluminazione.com)

Art Direction and Supervision  
GERECON ITALIA  
Claudia & Edoardo Brogini

©BCM illuminazione 2026



