

OUTSIDE MOUNTED BAILERS

RA554130 Mini
RA554136 Large

1. Select desired location for the bailer (consider class rules are applicable). Mark outline of the bailer using the supplied template.
2. Cut the hole for the bailer with a jigsaw. Fill and seal the cut surfaces with a waterproofing agent to ensure water ingress is minimised.
3. Mark the mounting holes by installing the bailer into the hole just cut.
4. Drill out the mounting holes as required:
RA554130 Mini - 4 holes @ 3.5mm (1/8") diam.
RA554136 Large - 6 holes @ 5.5mm (7/32") diam.
5. Countersink mounting holes as per diagrams below.
6. Mount the bailer in position using a marine grade sealant or waterproofing product around the contact surface between the bailer and the hull.
7. Affix the bailer with nuts and bolts provided, applying silicon to the bolt holes.
8. Bolts should be cut to length and smoothed following installation.

See Service Kit Installation sheet for gasket replacement.

*Cutting and installing through-hull and skin fittings should be conducted by appropriately skilled or qualified individuals.

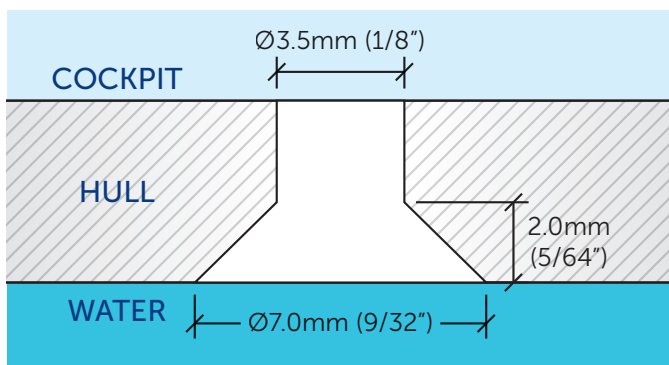

RA554130 Mini

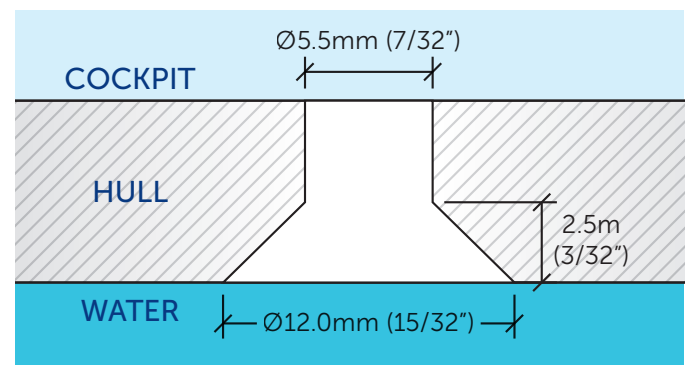

RA554136 Large