



SAFETY RAIL SYSTEM S22

Certified to:



European Standard EN795:2012, Type D: Personal fall protection equipment – Anchor Devices

Australian Standard AS1891.2:2001: Industrial fall-arrest systems and devices; Part 2: Horizontal lifeline and rail systems.

A reliable anchor device is an essential component of any personal protection system.

This system provides a method of attachment for use in conjunction with personal protection equipment to protect against falls from a height, such as when working outside of conventional guardrails for cleaning and maintenance purposes. It shall not be used for lifting equipment or for any other purpose.



Important Advice

- The system is tested and certified to the European Standard EN795:2012 Type D, and the Australian Standard AS1891.2.2001 Part 2, by Lloyd's Register, Copenhagen (Denmark), and is appropriate for single person use only.
- This anchor device is designed for the attachment of components of a personal fall protection system (harnesses, lanyards, fall arresters and other devices) in accordance with EN363, Personal fall protection equipment – Personal fall protection systems, and/or AS1891.1 or AS1891.3.
- Each harness or device must be secured to a separate attachment point.
- If this anchor device is to be used as part of a fall arrest system, the user must be equipped with a means of limiting the maximum dynamic forces exerted on the user during the arrest of a fall to a maximum of 6KN.

System Description

The complete Safety Rail System consists of the following components:

- One track rail with plunger stop holes at 50mm centres and mounting holes at 100mm. For standard length track rails, as delivered from the manufacturer, the centre of the last mounting hole at each end of the track rail is located 48mm from the end. For tracks cut to length on site, the maximum allowable distance from the last mounting hole centre to the end of the track rail is 50mm.
- One tandem sliding car assembly consisting of two cars joined together with a connecting plate.
 - Each car has a single attachment point for personal protection equipment.
 - One of the cars has a spring-loaded plunger to allow the assembly to be fixed in position at any of the stop holes in the track rail. This plunger can be disengaged to allow the free movement of the car assembly along the rail.
- Two end stops installed at the extremities of the track rail.

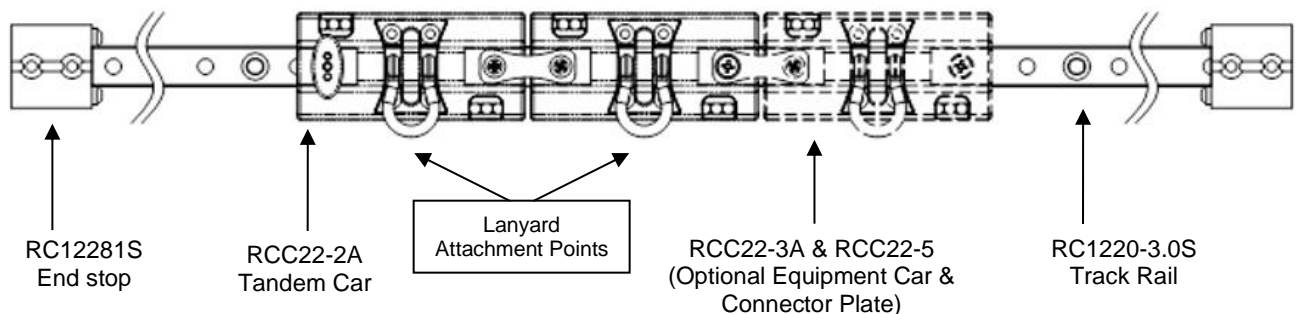

Features

- Marine grade aluminium alloy cars, track rails and end stops, anodised for corrosion protection and long service life.
- Recirculating Torlon® ball bearings for free running, low friction performance and low maintenance. (*Torlon® is a registered trademark of Solvay Advanced Polymers*).
- Grade 316 forged stainless steel pivoting shackles for lanyard attachment.
- Rubber buffers for reduced vibration and to lift pivoting shackles away from car body for quick access.
- Spring-loaded stainless steel plunger for simple, positive re-positioning at stop locations. Can be locked in the disengaged position to allow free movement along the track rail. The elliptical knob is easy to grip and turn, and indicates clearly whether the plunger is engaged or not.



Plunger down, car fixed in position



Plunger up, car ready to move to new position



Plunger up and locked, car free to move along track rail

- The track rail can be mounted in either a vertical plane (90°), horizontal plane (0°) or at an incline between 0° and 90° as shown below.

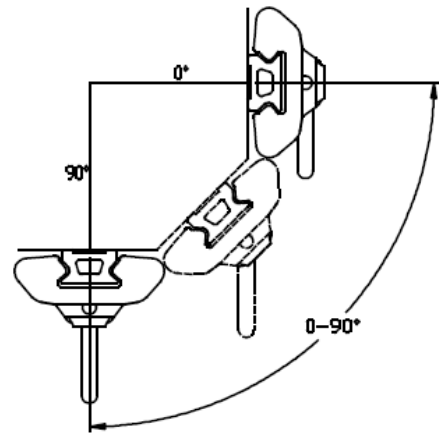
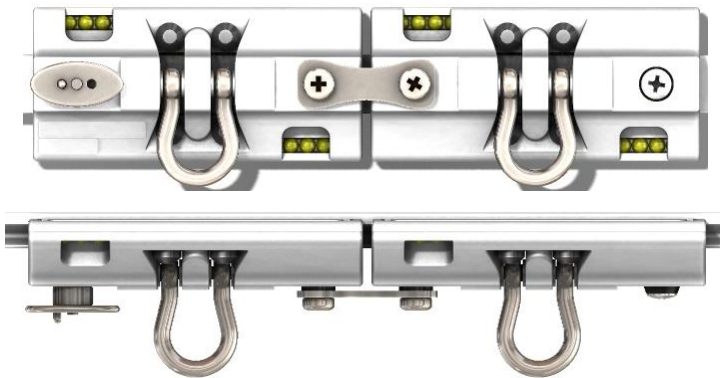

Options

- Longer runs can be achieved by using more than one section of track rail and trimming to length as required, provided that the distance between mounting fasteners never exceeds 100mm.
Note: When using standard length track rails as delivered from the manufacturer, the distance between fasteners across a track join will be 96mm.
- The joining insert RC1221J is used to aid alignment when fitting multiple sections of track rail.
- Additional sliding cars for supporting tools or equipment can be connected to the main tandem car RCC22-2 with the connector plate RCC22-5.
- Cover plate RC12281PS can be fitted to the end stop RC12281S with the screws provided to conceal the exposed end of the track.

System Components

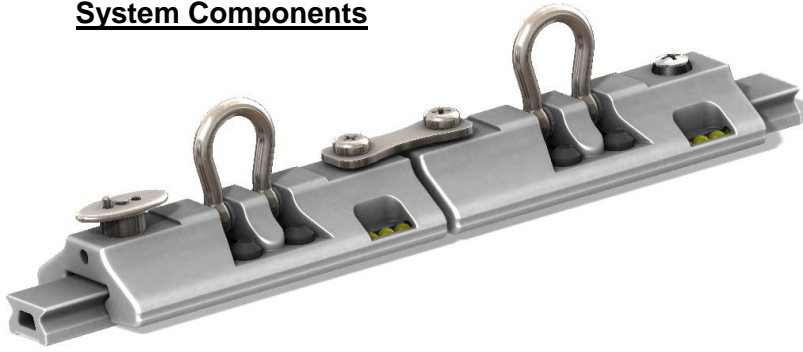

RCC22-2A

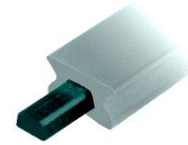

RC1221J



RCC22-1A



RCC22-5



RC12281S



RC12281PS



RCC22-3A



RC1220-3.0S *

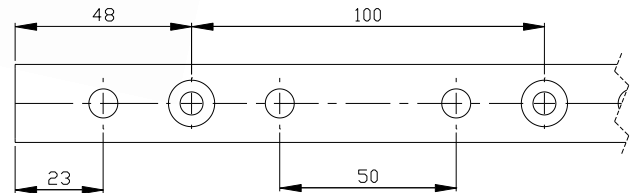
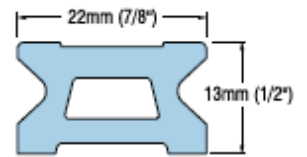

Part No.	Description	Length		Width	
		mm	in	mm	in
RCC22-2A	Tandem Car, 2 Attachment Points, Plunger Stop	254	10	58	2 5/16
RCC22-1A	Single Car, 1 Attachment Point, Plunger Stop	124	4 7/8	58	2 5/16
RCC22-3A	Single, Car, 1 Attachment Point	124	4 7/8	58	2 5/16
RCC22-5	Connector Plate including Screws				
RC12281S	Track Rail End Stop	50	1 31/32	45	1 25/32
RC12281PS	End Stop Cover Plate including screws				
RC1221J	Track Rail Joiner				
RC1220-3.0S	Track Rail, mounting holes at 100mm centres, plunger stop holes at 50mm centres*	2996*	118	22	7/8

* Last mounting hole is centred 48mm from each end of the track; mounting holes across track join will be at 96mm centres.

Installation

- The Anchor Device should only be installed by competent persons or competent organisations.
 - The installation should be verified appropriately (e.g. by calculation and/or testing).
 - Note must be taken of the maximum loads that could be exerted on the structure and fasteners by the anchor device as detailed below.
 - It is recommended that the structure used to hold the fasteners is stiff enough to ensure there is no failure of either the fastener or structure at these maximum loads as well as ensuring there is no permanent deformation or deflection of the anchor system under the service load of 1KN.
 - Consideration should also be given to the material used in the structure so that it does not cause corrosion in either the fastener or the structure. Isolation between the fastener and the structure may be required.
 - The track rail is mounted using 6mm countersunk Grade 316 Stainless Steel fasteners at 100mm centres. Fasteners should have a minimum strength of 620MPa to meet the load requirements detailed below. Use of M6 hexagon socket countersunk head, stainless steel A4-70 DIN7991 screws is recommended, installed at a torque setting of no more than 4.5Nm as per industry standards.
 - Longer runs can be achieved by using more than one section of track rail and trimming to length as required, provided that the distance between mounting fasteners never exceeds 100mm.
- Note: When using standard length track rails as delivered from the manufacturer, the distance between fasteners across a track join will be 96mm.*
- The track rail must be mounted horizontally (i.e. parallel to water plane), within a tolerance of $\pm 5^\circ$.
 - End stops are mounted using 6mm countersunk Grade 316 Stainless Steel fasteners.
 - Maximum loads that could be transmitted in service from the anchor device to the structure are:

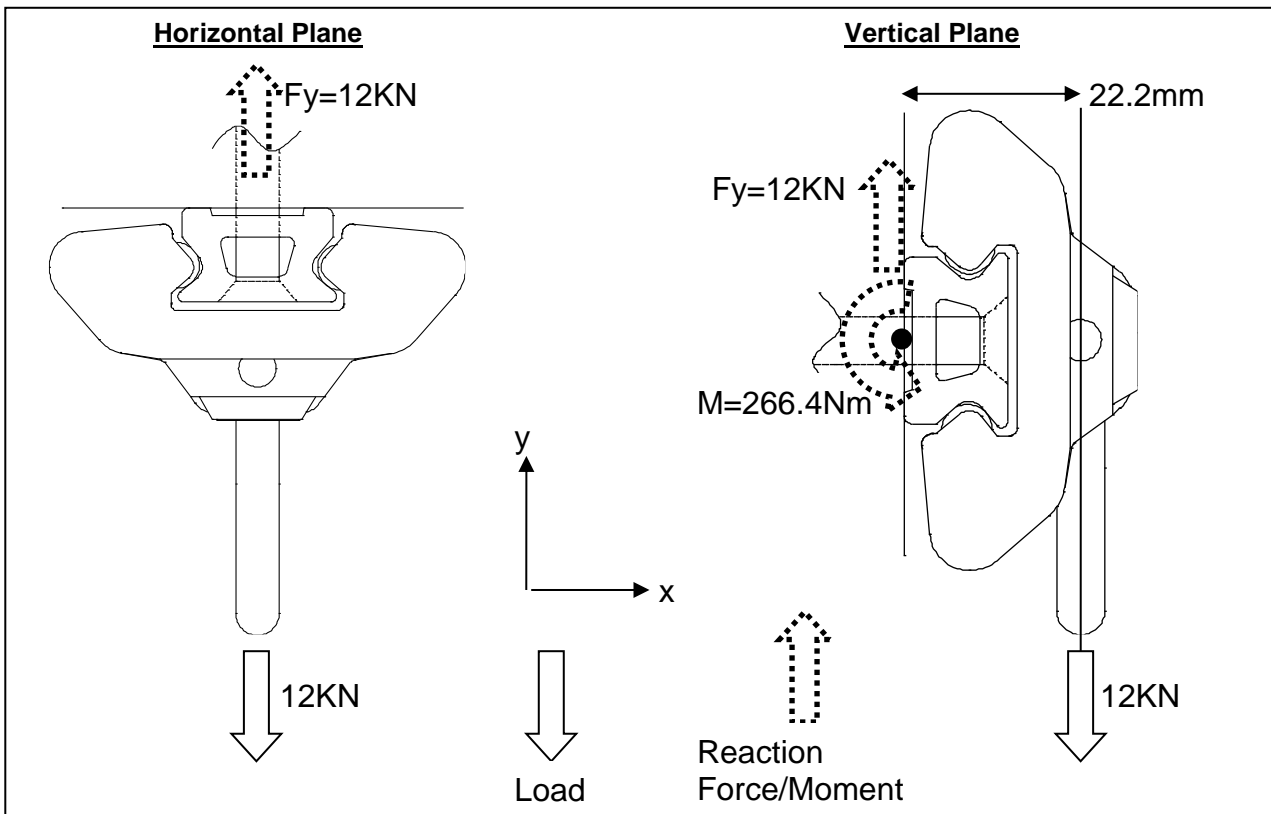

- The RCC22-2 tandem car is supplied with ball bearings already fitted, on a short loading track rail. To install the car, first remove the RC12281S end stop from the end of the installed track rail. Align the loading track rail with the installed track rail such that they are in contact with each other end-to-end, then slide the car onto the installed track rail and fit the end stop back in place.
- Note: DO NOT discard the loading track rail, which is required for retaining the ball bearings while installing or removing the car.*
- If the sliding car cannot pass through a discontinuity in the track (e.g. track ending before a sharp corner, then starting again around the corner), a second car must be available after the track discontinuity. The user must always be attached to at least one car when using the anchor device.
 - If the marking of the anchor device is not accessible after installation, additional marking near the anchor device is recommended.

Installation Documentation

Labels are affixed to each car by the manufacturer which indicate.

- The CE mark and the standard (EN795:2012 Type D) to which the product conforms.
- The part number and serial number, which must be referred to in all communication with the manufacturer or its authorised representatives.
- Indications that each car is for single person use only, and that users must read the information in this manual.

The installation documentation provides evidence that the installation has been carried out properly. Moreover, it is the essential basis for future examination of the anchor device, given that in many cases the fixing of the anchor device is not visible or accessible.

After installation, copies of the installation documentation should be handed over to the user. This documentation should be kept on site for the purpose of subsequent examinations of the anchor device.

Refer to **APPENDIX A** for the Installation Plan which must be completed by the installer.

Use of the System

- Each user must read and understand this user manual prior to first use of the system.
- If re-sold outside the original country of destination, it is essential for the safety of the user that the reseller provide all information relating to the installation, use, maintenance, periodic examinations and service of the system in the language of the country of destination.
- As with any workplace where hazards may be present, an appropriate rescue plan shall be in place for any emergencies that may arise during work involving the system.
- The system must be used only in conjunction with personal protective equipment approved to relevant standards.
- The user must NEVER rely on only one attachment point for personal protective equipment!
- The spring loaded plunger which locks the car in position along the track rail must ONLY be disengaged from the track rail while the user is changing position. Once the user is in position, the plunger MUST be re-engaged to hold the car in position and limit the user's movement along the track rail.

Inspection Procedures

Before each use, and in conjunction with Annual and 5-Yearly Inspections:

For the safety of users, a visual inspection of the system must be carried out by a competent person before each use to verify the following conditions:

- The track rail is securely fixed to its mounting surface and both end stops are in place at the extremities.
- The sliding cars run smoothly and freely on the track rail.
- The lanyard attachment points (pivoting shackles) are free to articulate. (Any deformation in the shackle indicates a fall or overload of the anchor device and it must be replaced).
- There are no signs of excessive wear, corrosion, deformation or breakage of parts.
- The plunger used to fix the car in position is operating correctly.
- All screws in the sliding car assembly are in place and secure.

Annual Inspection:

It is recommended that the complete system be inspected annually by a competent person. In addition to verification of the conditions for use of the system noted above, the annual procedure will include inspection of each car according to one of the following methods:

Method 1 – Inspection of car when installed on track rail:

- With the car installed on the track rail, the recirculating ball bearings in each ball race are visible for inspection through a cut-out slot on each side of the car. Each bearing race contains a single black ball for use as a tracer to mark the start/finish point of the recirculating bearings. Move the car slowly along the track until the black tracer ball is visible in one of the cut-out slots.
- Moving the car a further 500-600mm along the track, observe the recirculating ball bearings to check for any balls that appear worn or damaged, until the black ball appears again to indicate that a full circuit has been completed.
- When all ball bearings are present, pushing the balls apart with a small screwdriver will create a gap of approximately one ball diameter. A larger gap indicates that one or more balls are missing. Each individual car in the RCC22-2A tandem assembly, and the individual cars RCC22-1A and RCC22-

3A, must contain a total of 74 ball bearings (including the black balls) shared equally between the ball races on each side of the car.

- Any ball bearings that are missing, or that appear worn or cracked, must be replaced. The car will need to be removed from track as described in Method 2 in order to replace any lost or damaged ball bearings. Use only replacement ball bearings supplied by the manufacturer.
- The plunger assembly may be lubricated with a light grease. Lift the spring loaded plunger and apply grease to the exposed rod below the elliptical plate.

Method 2 - Inspection of cars when removed from track rail:

- To remove a car from the track rail, use the short loading track rail that was originally supplied with the car. (If no loading track is available, contact the manufacturer before proceeding).
- To remove the car, first remove the RC12281S end stop from the end of the installed track rail. Align the loading track rail with the installed track rail such that they are in contact with each other end-to-end, then slide the car onto the loading track rail.
- Once the car is transferred to the loading track rail, the recirculating ball bearings can be inspected from the underside of the car.
- Each bearing race contains a single black ball for use as a tracer to mark the start/finish point of the recirculating bearings. A small screwdriver may be used to push the ball bearings along the race to verify that they are free to circulate. Check for any balls that appear worn or damaged.
- If all ball bearings are present, the balls can be pushed apart to leave a gap of slightly less than one ball diameter. A larger space indicates that one or more balls are missing. Each individual car in the RCC22-2A tandem assembly (and the individual cars RCC22-1A and RCC22-3A) must contain a total of 74 ball bearings, including the black balls.
- Any ball bearings that are missing, or that appear worn or cracked, must be replaced. Use only replacement ball bearings supplied by the manufacturer.
- The plunger assembly may be lubricated with a light grease. Lift the spring loaded plunger and apply grease to the exposed rod below the elliptical knob.

5-Yearly Inspection

Follow the instructions for Method 2 in the Annual Inspection Procedure to remove each car from the working track rail using the short loading tracks. Refer to Appendix 5 for procedural checklist and record sheet.

General inspection recommendations:

- The manufacturer should be contacted if the labels on any car are found to be missing or illegible.
- In case of any doubts about the condition of the system, or if any component is found to be damaged in any way, the parts must be immediately removed from service. The system must not be used until repairs are completed and approved in writing by a competent person.
- No changes or alterations may be made to the components of the system without the manufacturer's prior written consent. Any repair must be carried out according to the manufacturer's procedures.
- After any fall, the system must not be used until it has been inspected and a competent person has confirmed in writing that it is safe to do so.

Maintenance

- Regular rinsing of all components with fresh water is required to help to prevent the build up of salt and contaminants and ensure efficient operation of the system. A mild soapy solution may be used to remove accumulated contaminants, followed by thorough rinsing with fresh water.
- Spray lubricants should not be used on the rail and ball bearings as they can lead to accumulation of contaminants and dirt which will compromise the long term performance of the system.

Record Keeping

- It is recommended that the anchor device is marked with the date of the next or last inspection.
- It is recommended that a record be kept for each component of the system, with particular regard to installation, inspection, maintenance and service interventions.
- Refer to APPENDIX B for the Equipment Record sheet that should be filled out for each component of the system by the competent person inspecting the safety rail system. This forms an inspection, maintenance and repair history for each component of the system.
- If any component of the system is inspected or repaired by Ronstan authorised personnel, a Ronstan Record of Inspection and Revision sheet will be completed. This is to be kept by the user with the Equipment Record and form the Inspection and Maintenance History for the system.
- Refer to APPENDIX C for the Annual Inspection and Revision procedural checklist and record sheet.
- Refer to APPENDIX D for the 5-Yearly Inspection and Revision procedural checklist and record sheet.

Re-Seller Contact Details

If the system or any of its components have been supplied by a company or organisation other than the manufacturer, contact details of the supplier may be recorded in the space below:

APPENDIX A

SAFETY RAIL INSTALLATION PLAN

NOTE: THIS MUST BE HANDED OVER TO THE USER AFTER INSTALLATION, COPIES MUST BE DISPLAYED AT ALL ACCESS POINTS TO THE SAFETY RAIL SYSTEM.

BUILDING/VESSEL:

NAME:

DESCRIPTION:

ADDRESS:

CUSTOMER:

NAME:

ADDRESS:

CONTACT PERSON:

CONTACT DETAILS:

INSTALLER:

NAME:

ADDRESS:

CHIEF INSTALLER:

CONTACT DETAILS:

ANCHOR DEVICE:

DESCRIPTION: Series 22 Safety Rail System

MANUFACTURER: Ronstan Denmark ApS

ADDRESS: Jægervangenget 36
7100 Vejle, Denmark

CONTACT DETAILS: Ph) +4576427777
office@ronstan.dk www.ronstan.com

NUMBER OF CARS USED: _____

LENGTH OF TRACK USED: _____ m

CAR PART NUMBER(S):

CAR SERIAL NUMBER(S):

(this information can be found on the product labels)

FIXING INFORMATION

FASTENER DESCRIPTION: _____

FASTENER STRENGTH: _____

FASTENER MANUFACTURER: _____

TORQUE USED TO INSTALL FASTENERS: _____

DESCRIPTION OF SUBSTRATE STRUCTURE THAT FASTENERS ARE FIXED TO:

WERE NUTS & WASHERS USED? _____

IF NOT, HOW ARE THE FASTENERS FIXED TO THE SUBSTRATE?

IS THE THREADED END OF THE FASTENER ABLE TO BE ACCESSED FOR INSPECTION AND MAINTENANCE?

REMARKS: _____

Declaration:

As the Chief Installer, I declare that the Safety Rail Anchor System:

- was installed in accordance with the manufacturer's manual and installation instructions.
- was carried out according to this plan.
- was fixed to the specified structure and substrate in the method described.
- was fixed using the fasteners as specified.
- was commissioned in accordance with the manufacturer's information.
- was installed and commissioned in accordance with any additional relevant standards, for example:
 - o *EN795:2012, Personal fall protection equipment - Anchor Devices*
 - o *AS1891.4:2009 for single point anchorages*
 - o *MGN578 - Use of equipment to undertake work over the side on yachts and other vessels.*
 - o *Red Ensign Group Yacht Code, Common Annexes*
- was supplied with photographic information/documentation, especially where fasteners and the underlying substrate are no longer visible after installation.
- installation was verified appropriately by calculation and/or testing.
- was installed to meet the load requirements as detailed in the Manufacturer's installation instructions.

Date: _____

Signature: _____

APPENDIX B

EQUIPMENT RECORD				
Manufacturer: Ronstan Denmark ApS Jægervænget 36 7100 Vejle, Denmark		Contact Details +45 76 42 77 77 office@ronstan.dk www.ronstan.com		
Product: Series 22 Safety Rail System				
Part Number:				
Serial Number:		Date of Purchase:		Date of First Use:
Other Relevant Information (e.g. document number, details of supplier or installer):				
PERIODIC INSPECTION, MAINTENANCE AND REPAIR HISTORY				
Date	Type of intervention (periodic inspection, maintenance or repair)	Details (defects, repairs, other)	Name/Signature of Competent Person	Date of next periodic inspection

Safety Rail Cars

Procedure for Annual Inspection and Revision

<input type="checkbox"/> Inspection of working track(s) and end stops to ensure all fastenings are secure and there are no signs of damage.
<input type="checkbox"/> Inspection of ball bearings.
<input type="checkbox"/> Replacement of ball bearings if required.
<input type="checkbox"/> Visual inspection to identify any worn, deformed or damaged parts.
<input type="checkbox"/> Verification of plunger stop functionality.
<input type="checkbox"/> Lubrication of plunger assembly with a light grease.
<input type="checkbox"/> Check of pivoting shackle for wear or deformation.
<input type="checkbox"/> Visual inspection of car assembly for signs of corrosion
<input type="checkbox"/> Fresh water cleaning and removal of any contaminants.
<input type="checkbox"/> Replacement of rubber buffers if required.
<input type="checkbox"/> Replacement of any other worn or damaged components (note details below if applicable).
<input type="checkbox"/> Check operation of car on working track; verify again that track rail end stops are properly secured.
<input type="checkbox"/> Recording of inspection and revision in the Equipment Record, Appendix B in the User Manual.

Notes:

Part Number	Description	Quantity	Label Reference

Date: _____

Location: _____

Inspected by: _____

Safety Rail Cars

Procedure for Inspection and Revision at 5 Year Intervals

<input type="checkbox"/>	Inspection of working track(s) and end stops to ensure all fastenings are secure and there are no signs of damage.
<input type="checkbox"/>	Removal of car from track.
<input type="checkbox"/>	Visual inspection to identify any worn, deformed or damaged parts.
<input type="checkbox"/>	Verification of plunger stop functionality.
<input type="checkbox"/>	Lubrication of plunger assembly with a light grease.
<input type="checkbox"/>	Disassembly of car including removal of ball bearings and pivoting shackle.
<input type="checkbox"/>	Visual inspection of disassembled car for signs of corrosion, and inspection of shackle pin for wear.
<input type="checkbox"/>	Fresh water cleaning and removal of any contaminants.
<input type="checkbox"/>	Replacement of ball bearings if required.
<input type="checkbox"/>	Replacement of rubber buffers if required.
<input type="checkbox"/>	Replacement of any other worn or damaged components (note details below if applicable).
<input type="checkbox"/>	Re-assembly of car on loading track.
<input type="checkbox"/>	Installation of car on working track; verify again that end stops are properly secured.
<input type="checkbox"/>	Recording of inspection and revision in the Equipment Record, Appendix B in the User Manual.

Notes:

Part Number	Description	Quantity	Label Reference

Date: _____

Location: _____

Inspected by: _____