

Owner's Manual

WATER-PRO SERIES

COMPACT S-60/90 12/24V DC

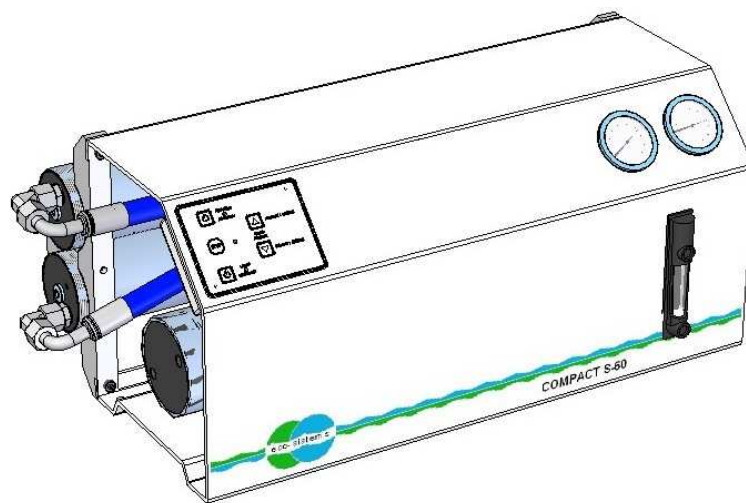

Version: 170221

Referencia: 45200012

Eco-Sistems Watermakers, S.L.

Oficina: C/ Horta nº 22 – Almacén: C/ Gran Vía Puig i Cadafalch nº 233

(08203)- Sabadell – Barcelona (Spain)

Tel: 34.93.710.89.50 – Fax: 34.93.712.23.55

E-mail: info@eco-sistems.com

Web: www.eco-sistems.com

WATER-PRO COMPACT S-60 12/24V DC

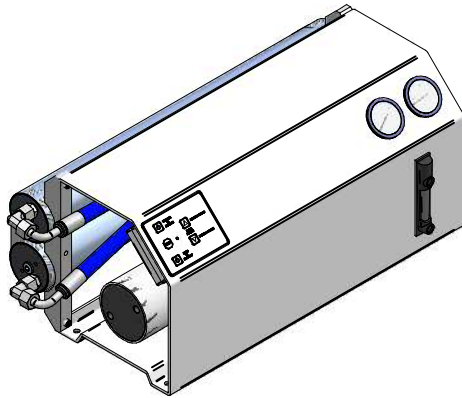

COMPACT-ASSY
S-60 12/24 V DC



POWER BOX

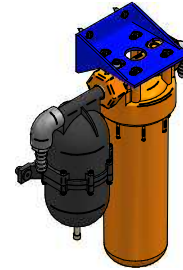

LOW PRESSURE
FILTER SET

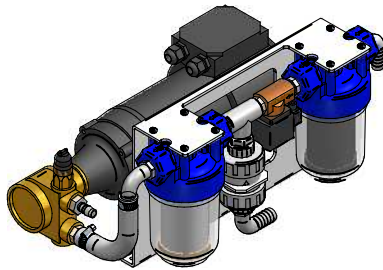

FEEDING-ASSY
S-60 12/24 V DC



FILTER WRENCH



TUBE 8X6 BLUE

CONNECTOR \varnothing 8TUBE X
1/4 BSP PLASTIC



2-ADAPTER 1/2 BSP
X 1/2 BARB PVC

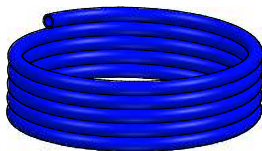

HOSE 1/2 BLUE

ADAPTER 3/4 BSP X
3/4 BARB PVC



HOSE CLEAR BRAID \varnothing 20

8 -HOSE CLAMP 12/22



2- HOSE CLAMP 16/27



WATER-PRO COMPACT S-90 12/24V DC

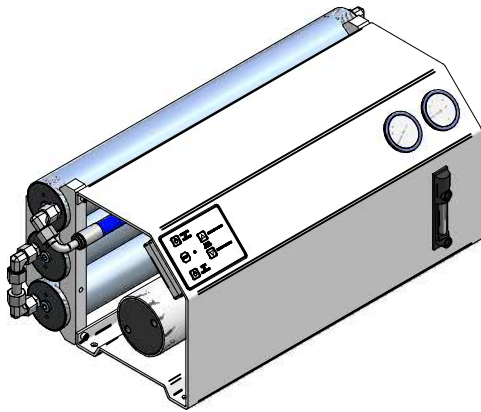

COMPACT-ASSY
S-90 12/24 V DC



POWER BOX

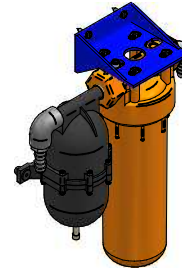

LOW PRESSURE
FILTER SET

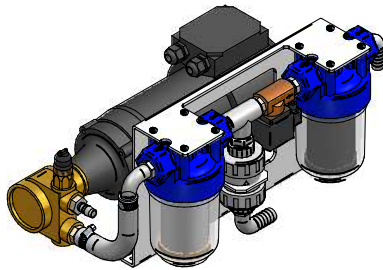

FEEDING-ASSY
S-90 12/24 V DC



FILTER WRENCH



TUBE 8X6 BLUE

CONNECTOR \varnothing 8TUBE X
1/4 BSP PLASTIC



2-ADAPTER 1/2 BSP
X 1/2 BARB PVC

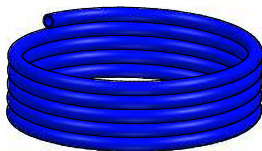

HOSE 1/2 BLUE



ADAPTER 3/4 BSP X
3/4 BARB PVC



HOSE CLEAR BRAID \varnothing 20



8 -HOSE CLAMP 12/22



2- HOSE CLAMP 16/27

TABLE OF CONTENTS

CHAPTER I:

• Installation, operation and maintenance.

- *System components.*
- *I.1. Installation.*
- *I.2. Hydraulic connections.*
- *I.3. Electronic control panel.*
- *Remote control panel.(optional)*
- *I.4. Electrical connection.*
- *Adjust and alarms.*
- *I.5. First start up.*
- *I.6. Start-up.*
- *I.7. Turning the unit off.*
- *I.8. Maintenance of the unit.*

CHAPTER II:

• Storage and Cleaning.

- *II.1. Storage precautions.*
- *II.2. Shutting down for short periods of time.*
- *II.3. Shutting down for long periods of time.*

CHAPTER III:

• Parts listing and exploded view of the ST-15/CERAMIC Eco-sistems pump.

- *ST-15/CERAMIC Eco-Sistems pump elements*

CHAPTER IV:

• Filter and Membrane Replacement.

- *IV.1. Changing the filters.*
- *IV.2. Membrane replacement.*

CHAPTER V:

- Warranty and identification sheet.**
- Dealers and After-Sale Service List.**

CHAPTER I

**INTALLATION, OPERATION
AND MAINTENANCE**

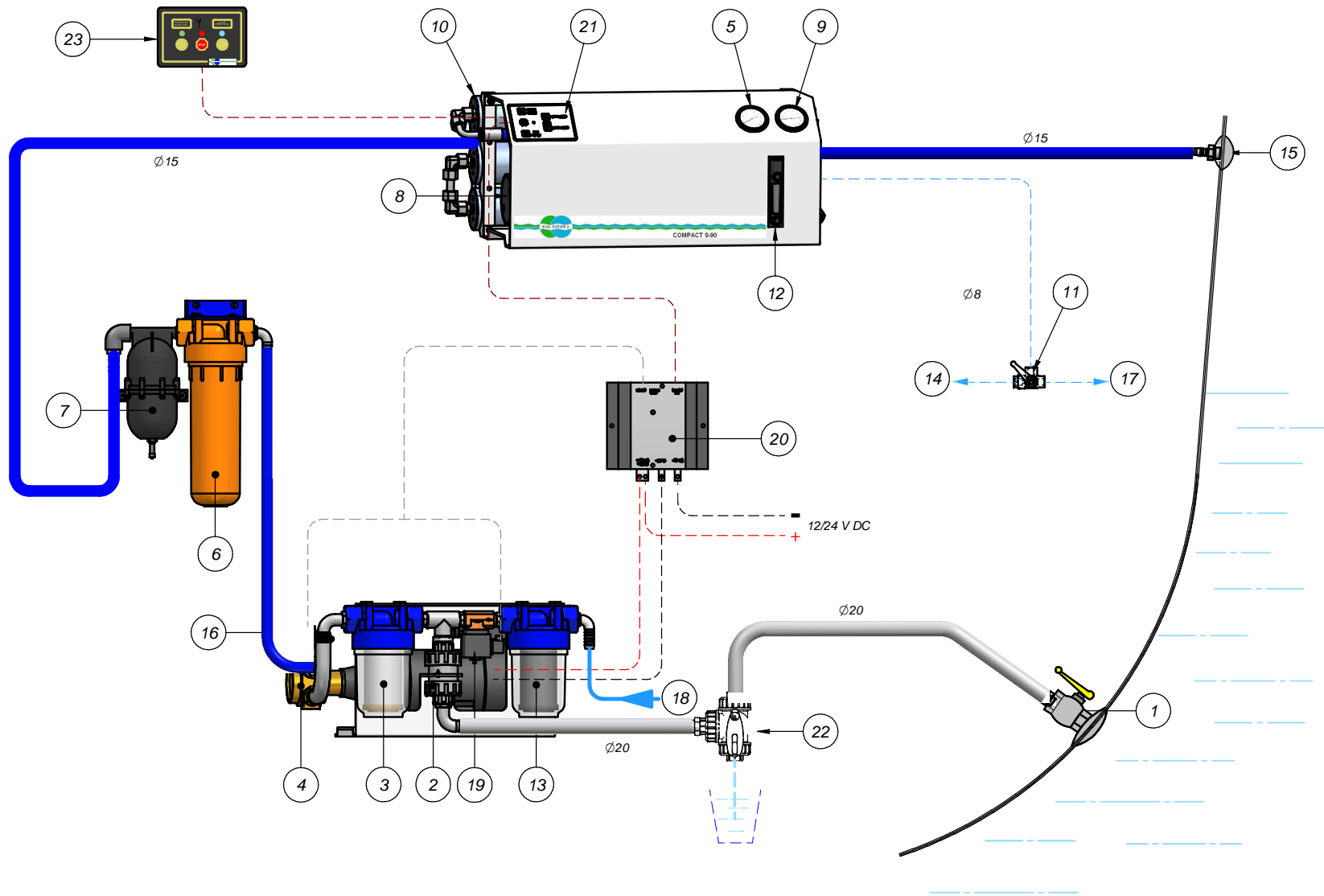

WATER-PRO COMPACT S-60/90 12/24 V DC

SYSTEM COMPONENTS

1. - Seacock valve to uptake the sea water.
2. - Check Valve.
3. - Protection pre-filter (Washable mesh filter).
4. - Low pressure booster pump 12/24V DC motor.
5. - Low Pressure Gauge.
6. - 5 microns filter contraîner.
7. - Expansion Vessel.
8. - ST-15/CERAMIC High pressure pump with energy saving system.
9. - High Pressure Gauge.
10. - R.O. Membranes and vessels.
11. - (OPTIONAL) -Three ways valve for the produced water.
12. - Produced Water Flow meter.
13. - Anti Cl carbon filter.
14. - Produced water output to the tank.
15. - Brine discharge thru-hull.
16. - Switch.
17. - Direct produced water output. (CONTROL)
18. - Boat fresh water input
19. - FLUSHING Solenoid Valve.
20. - Power Box.
21. - DIGITAL Control Panel.
22. - (OPTIONAL) Three way valve for wintering.
23. - (OPTIONAL) Remote Control Panel.

I.1. Installation. (See diagram Chapter I Pages 1 and 2)

To install the unit the following inlet and outlet connections are needed:

- Sea cock valve (1) with a minimum nominal pitch of 3/4" Gas for sea water intake, which should be installed as low as possible at the bottom of the hull in order to prevent possible cavitation problems due to air suction.
- 1/2" Gas female thread through-hull fitting (15) to connect the internal blue tube Ø15 that drains rejected the water into the sea.
- 1/4" Gas female thread inlet in the main tank for the intake of fresh water produced
- Ball valve installed in the water line pressure out of the boat with female R 1/2 "Gas for water intake (18) Wash System.
- Options: Three way valve (22) for winter storage and valve (11) for a direct take of the produced fresh water.

WARNING

It is very important to place the feeding assembly below the waterline and to check that at least a minimum flow of 15 litres/ minute is supplied to the system to prevent the pump from cavitation due to fall in pressure.

The rest of the components belonging to the unit can be installed at a higher level, provided that they do not exceed a distance of 4 or 5 metres.

The membranes are normally delivered assembled inside their containers. In case they haven't been factory-installed, look in chapter IV for the assembling instructions.

After all components have been placed and fixed, the unit will be ready for hydraulic and electrical connection, which will be covered in the following sections.

I.2. Hydraulic connections.

The connection between the various components will be made with the tubes supplied with the unit, as shown in the diagram in Chapter I Pages 1 and 2.

- The two suction connections between the sea cock valve (1) and the check valve (2) will be made using the transparent Ø20 tube.

The remaining seawater circuit sections will be made with the blue tube Ø15. **This is a special tube developed to work with pressures up to 20 bar, and it is not recommended to replace it with a different one (even with similar characteristics)**

To make the connections proceed as indicated below:

- Elbow inlet (18) Vessel pressure circuit
- Pump outlet (4) and 5-micron filter inlet (6).
- Pre-filter outlet (6) and the inlet elbow (E) in the high-pressure pump (8).
- Outlet elbow (S) in the high-pressure pump (8) and the brine outlet (15).

The referred elbows marked as E and S are located in the back / lower part of the high pressure pump (8)

Connect the elbow located in the lower part of the flow meter (12) to the to the main tank adaptor using the blue Ø 8 polyamide tube (this adaptor is delivered with a plastic cap, remove it before the installation).

As an optional, a three way valve (11) can be installed in the line of produced water to have a direct fresh water outlet. It can be very useful having a direct fresh water outlet, without passing trough the main tank, (this valve must be one that never closes the water flow).

As a general rule, the tube sections should be as short and as straight as possible to avoid unnecessary pressure drops, and the connections should be completely airtight so that air does not enter the circuit during the water absorption process.

I.3. Electronic Control Panel

The electronic Control Panel (21), shown in the diagram of Page 1 Chapter I consists of two push buttons that allow for an increase or decrease in the Motor pump's feeding speed (4) and three buttons equipped with light indicators that allow for a complete control of the system.

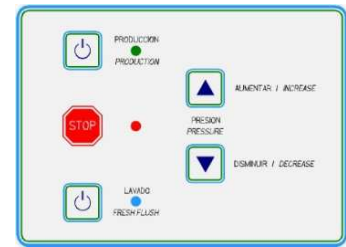

- The first button, from left to right, is marked with the word PRODUCCION/PRODUCTION and it is equipped with a green LED light. It starts the system.
- The central button is marked with the word STOP and it is equipped with a red LED light. It stops the system.
- The third button, from left to right, is marked with the word LAVADO/FRESH FLUSH and it is equipped with a blue LED light. It starts the timed Fresh Water Flush cycle.

For a proper operation, the system doesn't allow the change from the Production function to the Flush function without pressing the STOP button. The flushing time is programmed for a period of 2 minutes where the booster (feeding) pump is turning at the 60% of the normal production r.p.m.'s.

Remote Control Panel. (Optional)

The remote control panel (23) shown in the Diagram on Page 1 Chapter I consists of three buttons with the corresponding 3 light indicator. It allows for a total control of the system from a remote location on the boat. The connection cable length is 10 meters.

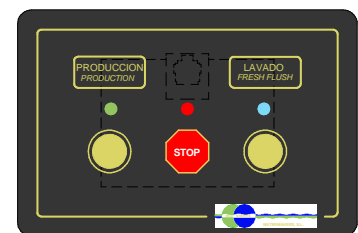

- Pushing the button marked with the word PRODUCTION and a green LED makes the system start to produce fresh water.
- Pushing the button with the word STOP will stop the system.
- The button marked with the word WASH and a blue LED starts the automated fresh water flush.

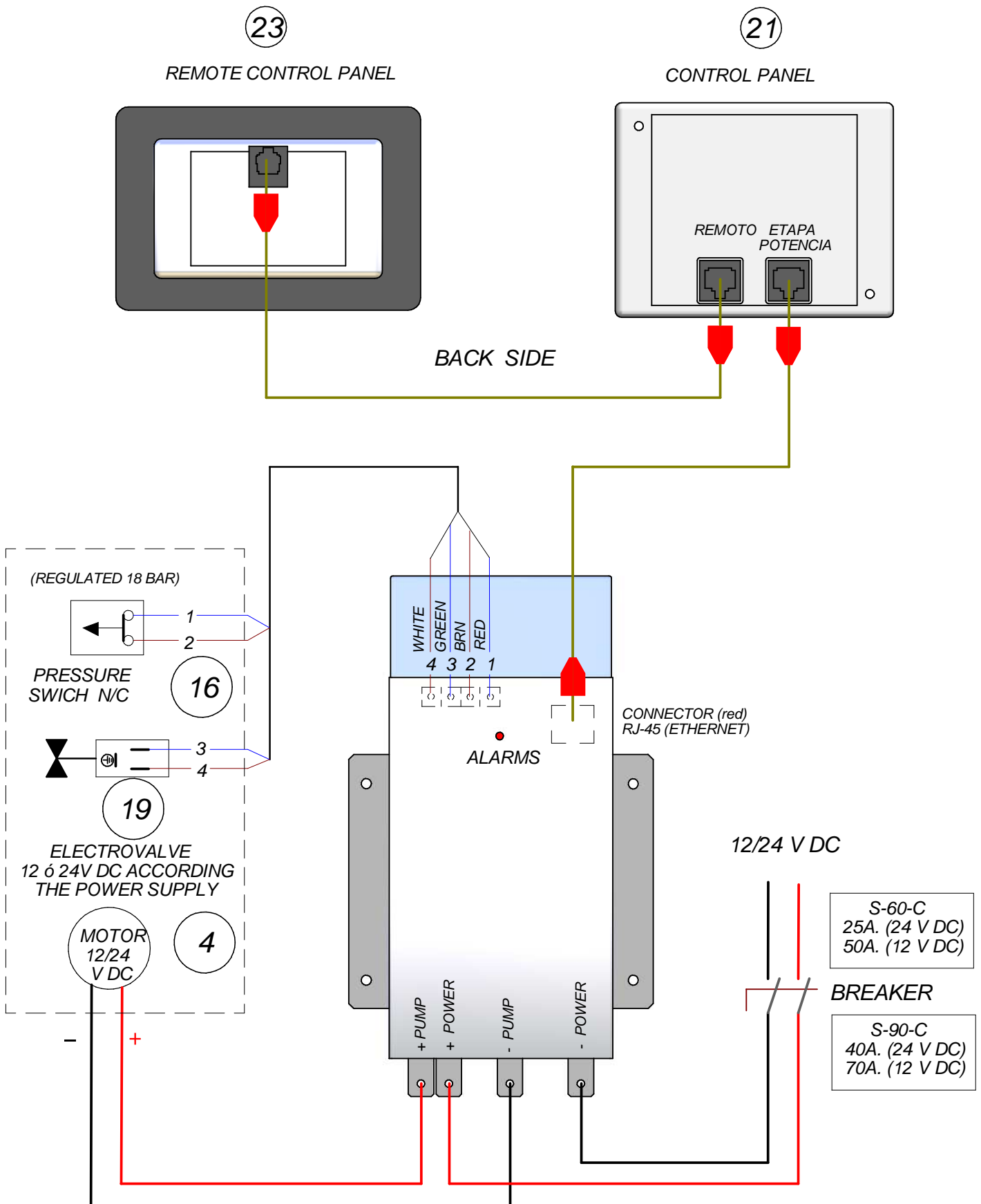

WATER-PRO COMPACT S-60/90 12/24V DC

I.4. Electrical Connection.

The system comes equipped with an electrical motor for the low-pressure pump 12/24V DC at 2000 rpm. It must be connected using the moisture shielded cable with a cross-section appropriate for the distance between the batteries and the motor. The recommended cables are the following ones:

Model / Power nominal motor	60 Litters/550wattios		90 Litters/750wattios			
	Batteries / Power Box	Dist.	12 v DC	24 v DC	12 v DC	24 v DC
From 0 to 5 meters			25 mm ²	10 mm ²	35 mm ²	16 mm ²
From 6 to 12 meters			50 mm ²	16 mm ²	70 mm ²	25 mm ²
Circuit Breaker			50 A	25A	70 A	40A

These sections are appropriate to prevent voltage losses greater than 1.6% of the rated voltage (0.2 V in 12 V DC).

A distance of more than 3 meters between the power box and the electric motor in the low pressure pump must never be exceeded. For longer distances than the ones provided in this table, please contact the manufacturer.

- Connect the two wires from the breaker with the corresponding power box terminals marked as power supply (20) as indicated in scheme of (Chapter I Page 6).
- Connect the motor-pump terminals (4) with the ones marked as “Pump” in the power box.
- Also a 4-wire 3 meter long cable is supplied with the motor, it comes connected to the electro-valve and the pressure switch by one of its ends, this end of the cable must be passed through the seals of the box and connected to their respective terminals.
- Connect the control panel (21) and the head (20), using the supplied 6 meter cable with red connectors RJ-45 (Ethernet) at both ends, taking care to connect one of them to the plug marked as POWER STAGE. The remote control panel (23) OPTIONAL must be connected to the plug marked as REMOTE using the 10 meter cable
- Make sure the pump’s direction of rotation is the correct one, marked by the water inlet and the outlet, if it isn’t, reverse the polarity on the motor connection.(Chapter I Page 6)

As a general rule, the electric grid circuit should be properly protected, taking care to oversize the connection cables to avoid voltage drops and unnecessary power consumption.

ELECTRONIC 12/24 V DC CONTROL PANEL ADJUSTS

(Recommended for experts only)

FLUSH WATER FLOW ADJUST

- Turn on the system while pressing the LAVADO/FRESH FLUSH button, the blue LED on the control unit will turn on.
- After this, each key press of the ▲ button will increase the pump's speed in one unit, and, every key press of the ▼ button will decrease it in the same way.
- Once reached the wanted flush water flow press the Stop button, the red led will get on, after releasing it the led will flash, this means the water flow has been adjusted.
- Switch off the system and switch it on again to return to its normal functioning

HOUR METER READING

- Switch the system on while pressing the Stop button in the control panel.
- Both green and red LEDS will flash a few times.
- Each green flash is equivalent to 400 working hours and each red flash is equivalent to 25 working hours. The total reading of working hours of the system is given by the sum of all green and red flashes.
- The maximum count will be 8 green flashes and 3 red flashes, which makes a 3275 hour reading, from that moment the hour meter gets self-restarted, starting a new reading cycle.
- The green led will flash 5 times when the system reaches 2.000 hours working, which means the pump's maintenance must be performed.
- Switch off the system and switch it on again to return it to its normal functioning.

12V DC FALL DOWN ALARM.

- The system will stop if the power sources voltage drops below 10 V DC, if this happens the RED led will start blinking at a 3 times per second rate.

ALARMS AND PROTECTION OF THE 12/24 V DC POWER BOX

- There is a 3 Amp fuse, it can be found under the cover.
- If the aluminum radiator exceeds a temperature of 65 degrees the red led located in the control panel will flash, then the power box will cut the power supplied to the motor pump and the power box. To restore the original system conditions proceed by turning off and on the unit.
- If the maximum pressure is exceeded the red led will remain on. To restore the original system conditions proceed to turn off and on the unit.
- Both excessive temperature and pressure will cause a failure in the system, for that reason the first thing to do will be finding the cause of the problem.

I.5. First Start Up.

- Check if all connections have been properly made and if the voltage at the terminals is the appropriate one.
- Check if the Sea Cock Valve (1) is opened. In case the optional valve (11) is not installed, its connection to the main tank will be removed.
- Make sure there is pressure in the boat's fresh water circuit.
- Switch on the system by pressing the “**PRODUCCION**” button and check that the pump's direction of rotation is correct, gradually increase the pump's motor speed with the “▲” button making sure not to exceed the 60Kg/cm², high pressure (red zone) indicated on the high pressure pump gauge (9).
- Check that pressure in the control panel pressure gauge (5) lies between approximately 12 and 14 kg/cm², and does not exceed 15 kg/cm² under any circumstances (red zone).
- The high pressure, indicated on the high pressure pump gauge (9), will gradually rise until stabilizing at approximately 45-60 kg/cm².
- In the first few minutes, some air bubbles will be observed in the panel control flow meter (12). Those bubbles come from the interior of the membrane and other system elements, causing some irregularities in the first high pressure work cycles. They usually go away without purging the circuit.
- Approximately 5 minutes after the start-up, the “test tank” (17) should contain about 5 liter of water produced in model 60 l/h (7.5 liter in model 90 l/h), which determines that the production rate is correct, press STOP to stop the feed pump, and after that, by pressing the FLUSH button the system will activate the electro-valve (19) and the pump will work at slower speed for about 2 minutes, stopping automatically once finished the flushing. By that time, a significant reduction in both high and low pressure will be noticed, due to the fact that the fresh water will has reached the membranes. This operation **must be repeated twice at least**, to clean the new membranes and eliminate the membrane preservative that may have accumulated inside them. During the flushing, the pressurized fresh water system on the boat must be “ON”, providing approximately a 10 liters per minute flow.

I.6. Start-up

- Before starting up the system make sure the sea cock valve (1) is completely open.
- Ensure there is pressure in the boat's fresh water circuit.
- Start the motor and check that the pressure in the low pressure gauge (5) lies between approximately 10 and 12 kg/cm², and does not exceed 15 kg/cm² under any circumstances (red zone).
- High pressure will gradually rise until stabilizing at approximately 45-60 kg/cm². There may be some differences depending on the temperature and salinity of the water.

I.7. Turning the unit off.

Before turning off the unit the system must be cleaned to prevent a compaction of the membranes due to the biological fouling in it, proceed as follows:

- Press STOP to stop the low pressure motor pump.
- Press LAVADO/ FLUSH and the system will run the flushing system.
- At this point the unit will take fresh water from the pressurized fresh water system in the boat. The low pressure pump must be ON, providing approximately a 10 liters per minute flow.
- For a proper cleaning of the membranes, the feed pump will work for 2 minutes timed period, and it will be done approximately at 60% of its normal performance.

- The high pressure will fall to around 20-30 kg/cm². This significant decrease in high pressure means that the seawater contained in the membranes has been cleaned out and replaced by fresh water. Changing the salinity and pH of the water in the membrane prevents the biological fouling from latching on to the membrane for a maximum period of 90 days. For longer periods see **Chapter II, Storage and Cleaning.**
- **As a safety measure keep the seacock valve closed (1) when the system is switched off.**

I.8. Maintenance of the unit.

- Regularly check the status of the Sea Strainer (3) and clean the mesh when needed.
- Replace the 5 micron filter with a new cartridge at the beginning of each season or every three months of continuous service.
- Change the charcoal cartridge at least once a year.
- When the pressure indicated in the high-pressure gauge (9) exceeds 65 kg/cm² (with a water temperature between 18°C and 25°C), the membrane should be replaced by a new one.
- Periodically check the pressure in the accumulator (7), it should be a 8 Kg/cm² pressure without producing low pressure oscillations.

(An annual inspection by the Technical Support Service is recommended).

CHAPTER II

STORAGE AND CLEANING.

VERY IMPORTANT

REMEMBER THAT FOR A LONGER LIFE OF YOUR MEMBRANE, YOU MUST CLEAN THE SYSTEM WITH FRESH WATER AFTER EVERY USE.

II.1 Storage precautions

PREVENTION OF CHEMICAL ATTACKS ON THE SYSTEM

Do not use for storage purposes, or expose the unit to, hydrogen peroxide, chloramine, chloramine-T, N-chloroisocyanide, chlorine dioxide, hypochlorite, chlorine, iodine, bromine, bromide, phenolic disinfectants or any other chemical element. The use of unauthorized chemical elements, or the abuse of authorized ones, will invalidate any warranty.

TEMPERATURE: Never expose the membrane during its storage to temperatures higher than 50°C or lower than 0°C. Never store the membrane vessel under direct sunlight. Freezing temperatures will result in mechanical damage to the system due to the expansion of air on freezing. This will cause irreversible damage to the membrane.

DRYING OUT: Never allow the membrane to dry out. If the membrane dries out, up to 30% of production flow will be lost. It would cause irreversible damages to the membrane. The membrane must always be kept damp.

BIOLOGICAL DIRT: Protect the membrane from biological dirt. Up to 40% of production flow will be lost if the membrane gets dirty with biological slime. Some production, but not all, can be recovered by following a thorough cleaning.

CHEMICAL DIRT: Protect the membrane from chemical attacks or dirt. Be careful when using the system in ports that may be polluted with chemical products, oil or fuel. Chemical attacks are not covered by the warranty.

STORAGE: The inside of the membrane, which is dark and damp, is an excellent place for microorganisms to reproduce. When the membrane is used, tested or operated intermittently, it is exposed to microorganisms. Up to 50% of production flow can be lost if the membrane is not stored correctly.

II.2. Shutting down for short periods of time.

Shutting down for a short period of time means when the unit will not be used for between one day and three months. An excellent and inexpensive way to protect the system and the membrane is the described in the **Switching off the unit** section which guarantees protection against the biological fouling in the membranes. As manufacturers we recommend that **immediately after** using the system you always flush it with freshwater from the main tank passing through the charcoal filter (13) in order to get rid of all rests of chlorine that may be in the water in the tank.

II.3. Shutting down for long periods of time.

(Recommended for experts only)

A long period of time or prolonged shutdown means when the unit will not be used for three months or more. In this case the unit must first be rinsed with chlorine-free fresh water, and after that stored with a chemical protector. This product inhibits bacteria growth while maintaining a high circulation flow and salt rejection in the membrane.

Follow these instructions carefully:

1. Before switching off the unit: make sure you have enough water in the boat's main tank and at the same time fill up another container with 5 liters of additional water that will be used to dissolve the preservative. Press STOP.
2. Press the "FLUSH" button and let the system be flushed with fresh water from the boat tank. **Remember that whenever the system is flushed, the pressurized fresh water system must be on.** After about 90 seconds the high pressure will decrease until reaching 20/30 Kg/cm², that fall will indicate the system has been washed with fresh water.

3. Dissolve of 30/40 grams of chemical protector (sodium metabisulfite) with the 5 liters of water you set aside in a different container and suction this solution using the auxiliary valve (22).
4. Close the sea cock valve (1) and start up the system by pressing **PRODUCCION**, and press **STOP** just before the chemical protector and water solution from the tank runs out. This way the entire circuit will contain this protecting solution.

Do not forget to keep closed the seacock valve (1) as a security measure.

5. When the unit is ready to be turned on once again, the sea cock valve (1) must set to open position and the valve (11) to the TEST position so the water produced initially is rejected. Proceed as described in **I.5 FIRST START-UP** (Chapter I Page 10).

Warning

Sodium metabisulfite is a caustic product that may cause serious irritation to the skin and mucus membranes. Take due precautions before handling, do not touch it directly and always work in well-ventilated spaces.

CHAPTER III

**PARTS LISTING AND EXPLODED VIEW OF
THE ST-15/CERAMIC ECO-SYSTEMS PUMP.**

Eco-Sistems ST-15/CERAMIC PUMP ELEMENTS

Part Number	Breaking-Up number	Description	Quantity
44015010	1	Distributor body ST-15	1
44015020	2	Superior plate	1
44015030	3	Central frame ST-15	1
44015040	4	Control Slider base	1
44015050	5	Lower plate	1
44015060	6	External cylinder liner	1
44015070	7	Intermediate small cap ST-15 (E)	1
44015080	8	Intermediate small cap ST-15 (S)	1
44015090	9	Control slider ST-15	1
44008110	11	Central slider	1
44408130	13	Cylinder	2
44406150	15	Distributor piston	2
44008170	17	Shaft Ø25 mm	1
44008180	18	Ring shank	1
44008190	19	Shaft stopper Ø25mm	1
44008200	20	Distributor cylinder	2
44008210	21	Distributor cap	2
44008220	22	Distributor necking cap	2
44008240	24	Cylinder cap	2
44008250	25	Plunger	2
44008261	26	Distributor slider	2
44008271	27	Ceramic base ST-14	2
44405270	30	Spring stopper/guide	6
44406130	31	Spring Ø3 x 12 A4	6
43420600	35	Tube 6x4	2
43620611	36	R 1/8 elbow gas tube Ø6x4	4
43710220	38	Cap R1/4" Gas	1
43802317	39	Screw ex. DIN-931 M6x170	8
43802320	40	Screw ex.9x04 DIN-931 M6x180	6
43812060	41	Anti-lifting nut DIN- 985 M6	2
43812100	42	Anti-lifting nut DIN- 985 M10	2
43821140	43	Flat washer DIN-125 Ø14 A4	2
43822060	44	Flat washer DIN-9021Ø6 A4	10
43822100	45	Flat washer DIN-9021 Ø10 A4	2

Part Number	Breaking-Up number	Description	Quantity
43823060	46	Grower ring Ø6 A4	14
43830606	47	Allen spike M6x6 A4	3
43850510	48	Cylindrical fastener DIN-7 A4 Ø5X10	2
43910540	50	O-ring Ø5x2	7
43911041	51	O-ring Ø10.5x2	2
43911240	52	O-ring Ø12x2	4
43911340	53	O-ring Ø13x2	1
43911540	54	O-ring Ø15x2	2
43912235	55	O-ring Ø21.95x1.78	6
43912350	56	O-ring Ø23x2.5	2
43914050	57	O-ring Ø40x2.5	2
43914550	58	O-ring Ø45x2.5	4
43915750	59	O-ring Ø56.8x2.62	2
43916460	60	O-ring Ø64x3	2
43917560	61	O-ring Ø75x3	4
43918470	62	O-ring Ø84x3.5	1
43942000-B	65	Seal Ø20x26x5	1
43942011	66	Seal Ø20x30x8	2
43942500	67	Seal Ø25x35x10	4
43944000	68	Seal Ø40x50x6	2
43946000	69	Seal Ø60x70x6	2

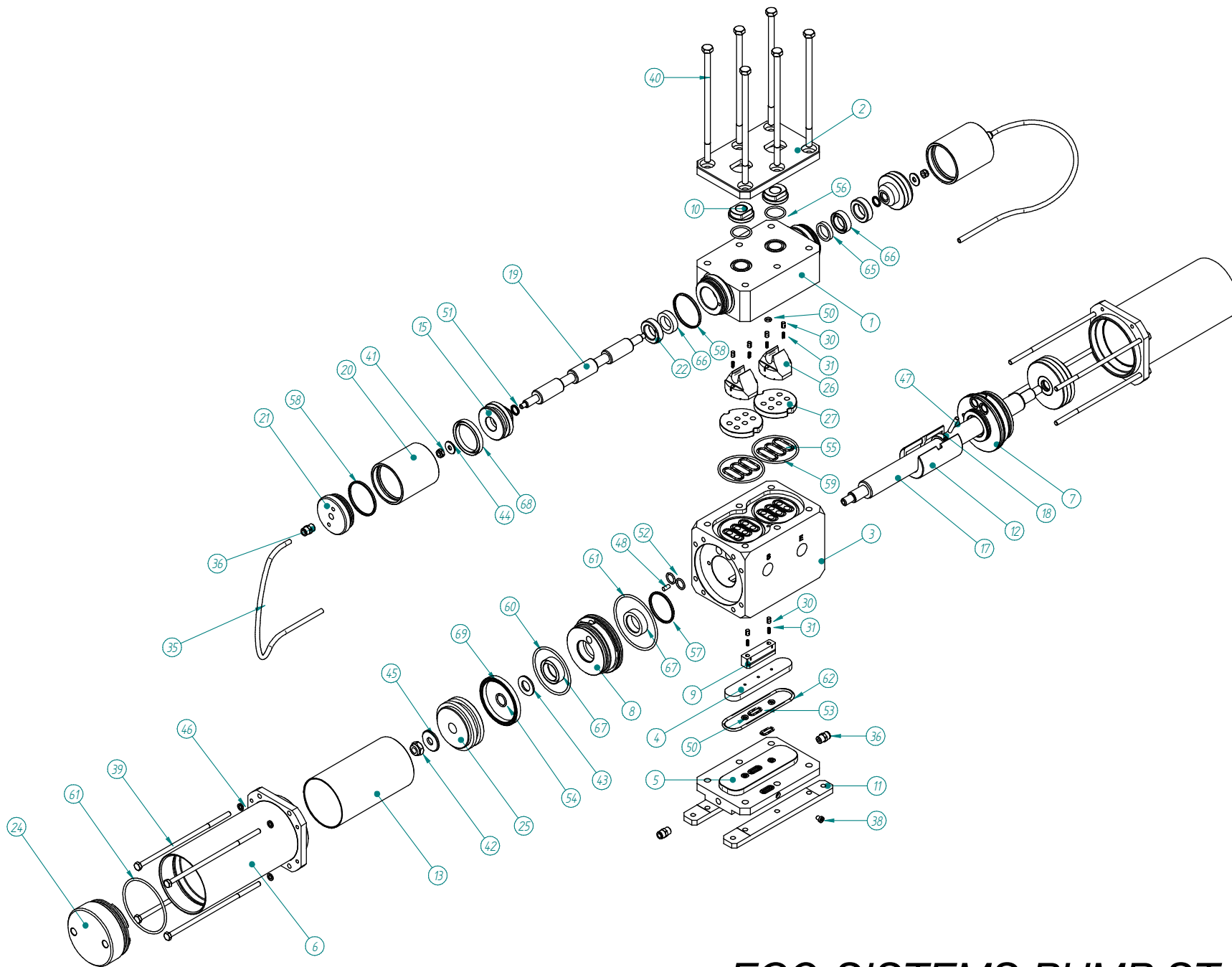

ECO-SYSTEMS PUMP ST-15

CHAPTER IV

FILTERS AND MEMBRANE REPLACEMENT

IV.1. Changing the filters.

When changing the filter cartridge make sure the sea cock valve is closed, before unscrewing the bowl filter that enables to remove the old cartridge and replace it with a new one which has the same specifications: 9 ¾ long, 5 micron calibrated filter. We do not recommend another type of cartridge; it could let unwanted particles entering the system.

Once replaced, screw the bowl filter back on and re-open the sea cock valve.

To replace the active carbon cartridge, disconnect the pressurized fresh water system in the boat, open a tab to not leave any residual pressure in the circuit, and replace the active carbon cartridge. Connect the boat pressurized fresh water system again.

IV.2. Membrane Replacement.

Follow these instructions to change the membrane, see diagram (Chapter IV Page 3)

- Before handling the unit, make sure there is no pressure in the circuit. If the pressure gauge indicates there is some, wait until it disappears.
- Dismantle the high pressure connectors, taking care not to loosen the fittings of the end caps (3) located on the vessels (1).
- Disconnect the fresh water outlet tube.
- Separate the membranes set from the frame by removing its screws for a better handling.
- Remove the steel connector set (5) between the two caps (3) and release the blue polyamide Ø8mm tube (6).
- Separate the flanges of the brackets (4) and remove the vessels.
- Remove the end caps (3) to get access to the membranes (2), unscrewing them with the help of a special pivot wrench.
- Once the membranes have been removed, clean the inside of the vessels with chlorine-free water. This dirt will be removed, and the water will act as a lubricant helping the insertion of the new membrane.
- Take the new membrane out of its packaging (the packaging is usually an airtight plastic bag).
- Check that the membrane seal have no malfunctions, damages or a excessive lack between it and the membrane. It must be placed with its lips against the water flow direction (see drawing). Lubricate the seal with water before being placed in the vessel. This lip seal is located at the end of the membrane by the brine outlet (OUTLET), there is no seal on the other end.

- Check that the membrane permeation tube fits properly into the O-rings inside the sealing caps (3).
- Place the membrane and screw the end caps previously removed, with the pivot wrench.
- Repeat the operation with the other vessels.
- Reassemble the vessels on their supports (4).
- Adjust properly the stainless steel connectors (5) and the blue Ø8mm polyamide produced water tube (6) between the vessels and tighten the screws that link the flanges to their brackets.
- Reassemble the membranes set to the frame fixing it with its screws.
- Reconnect the high pressure hoses, making sure the fitting nuts are well tight.
- Connect the fresh water outlet.

NOTE:

De location of the seal on the membrane, is different than in the 2540 Standard models used by other manufacturers, it is placed on the side marked as (OUTLET) with its lips against the water flow direction (FLOW).

Before restarting the unit, make sure the valve (11) (see drawing in Chapter I, Page 1) is in TEST position and proceed as indicated in Chapter I section 5 **FIRST START-UP**.

WARNING.- The membrane may have air inside and it needs a few minutes to be completely taken out.

