

SKYSOL PLEATEDSHADE

Order Form and Product Guide

Customer _____
 Address _____

Tel _____
 Fax _____
 Mobile _____
 Email _____

Order _____
 Quote _____
 Project Name _____
 Project Location _____
 Date _____

Item	Window ID	Retail Blind Sizes <i>If selected just give quantity required</i>	Size & Shape					Fabric Colour	Blackout Liner	Hold up option <i>(Poppers not available on Framfix blinds)</i>	Top or bottom stack	Hold down options <i>(Crossbar not available on Framfix blinds)</i>	Hold down peg colour <i>(bungee only)</i>	Fixing Options				Qty	
			Width	Drop	Shape type <i>See page 3</i>	A <i>(Cloth width)</i>	B <i>(Diagonal)</i>							C <i>(Diagonal)</i>	Face or Top Fix	valance <i>(Top stack only)</i>	No. of brackets		Distance between Bracket Centres
1		1			1				Navy	Yes	Poppers	Top	Poppers	White	Standard Fix	Framefix			
		2			2													2	
		3			3														
		4			4														
		5			5														
		<i>See table below for Dimensions</i>										Custom		Please contact Oceanair					
2		1			1			Navy	Yes	Poppers	Top	Poppers	White	Standard Fix	Framefix				
		2			2												2		
		3			3														
		4			4														
		5			5														
		<i>See table below for Dimensions</i>										Custom		Please contact Oceanair					
3		1			1			Navy	Yes	Poppers	Top	Poppers	White	Standard Fix	Framefix				
		2			2												2		
		3			3														
		4			4														
		5			5														
		<i>See table below for Dimensions</i>										Custom		Please contact Oceanair					

Maximum Sizes	X					
	≤1200mm	≤1400mm	≤1600mm	≤1800mm	≤2100mm	
Y	≤400mm	✓	✓	✓	✓	✓
	≤500mm	✓	✓	✓		
	≤600mm	✓	✓			
	≤700mm	✓				

Retail size	X	Y
1	381	305
2	508	305
3	635	305
4	762	305
5	1016	305

SKYSOL PLEATEDSHADE Order Form and Product Guide

Top Batten Fixings Positions

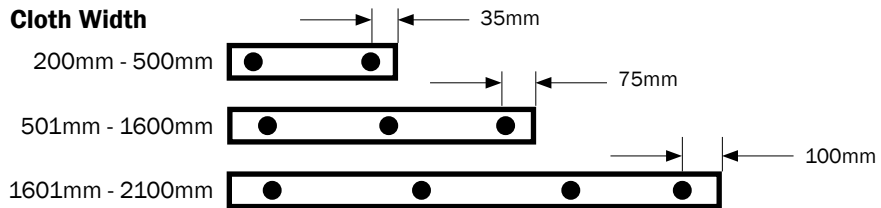

For stud positioning on shaped blinds, refer to drawing supplied with order

Hold Up (strap) Positions

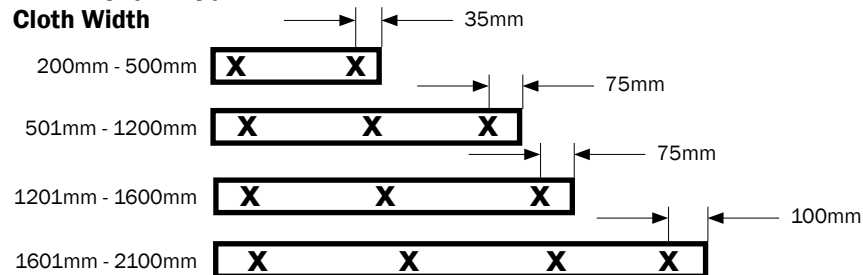

Hold Down Positions

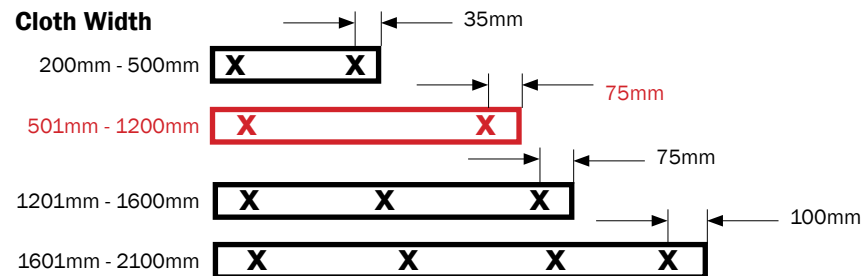

Crossbar Minigrip and Bungee positions

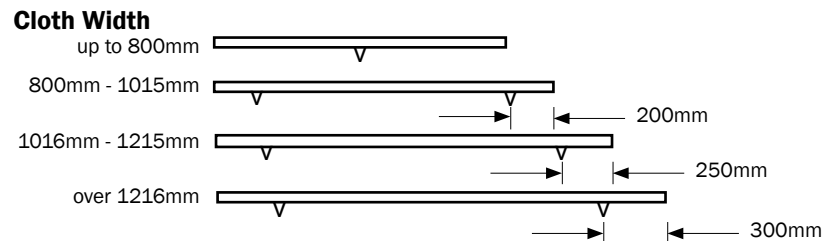

FrameFix bracket Layout configurations

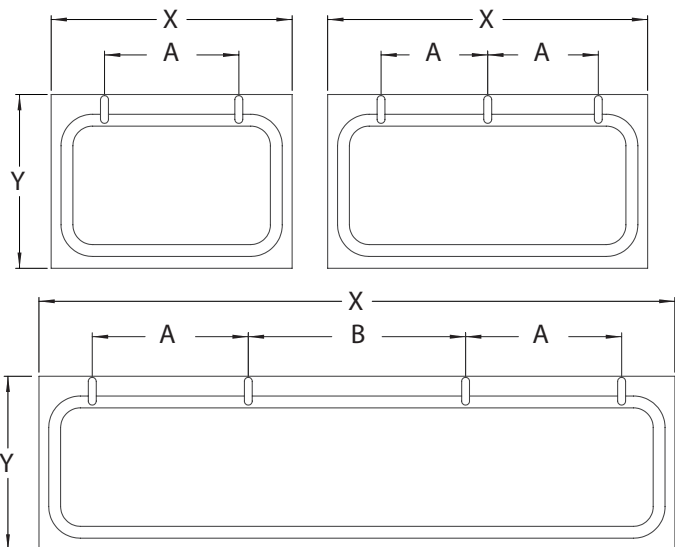

Bungee loop Sizes

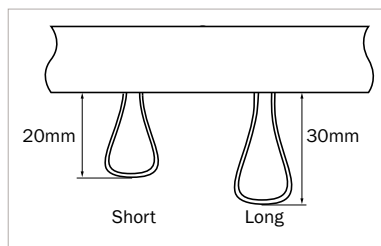

Face Fix

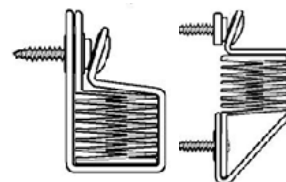

Top Stack

Bottom Stack

Top Fix

Bottom Fix

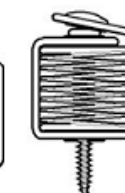

Top Stack

Bottom Stack

HOLD UP OPTIONS

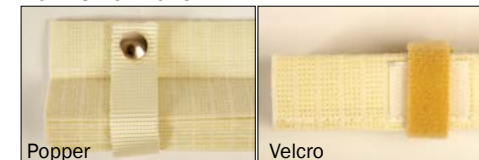

HOLD DOWN OPTIONS

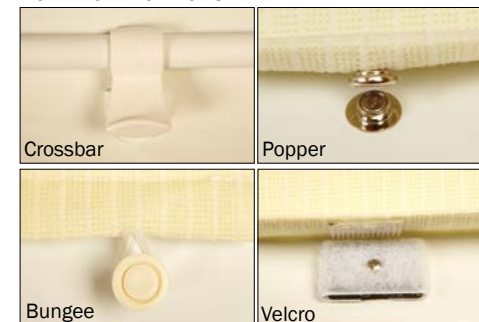

SKYSOL PLEATEDSHADE Order Form and Product Guide

Shapes

Shape 1 - Rectangle

Shape 5 - Custom shape to be approved by Oceanair

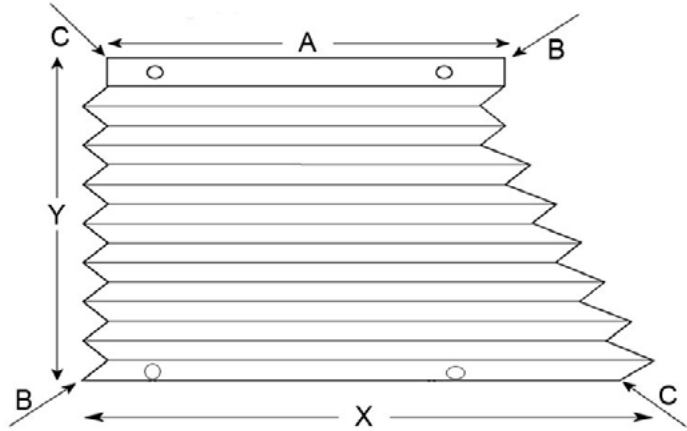

Shape 2

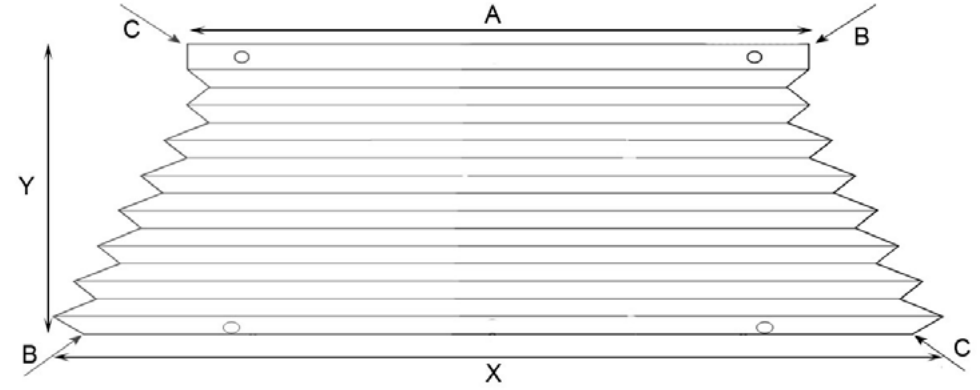

Shape 3

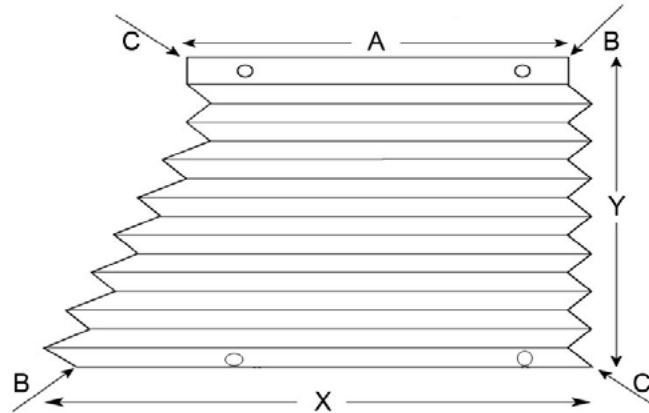

Shape 4