

## Signal reception socket outlets - TECHNICAL CHARACTERISTICS

### EDP socket connectors

#### Scope

Devices designed to realize information or telephone networks.

#### Cabling code

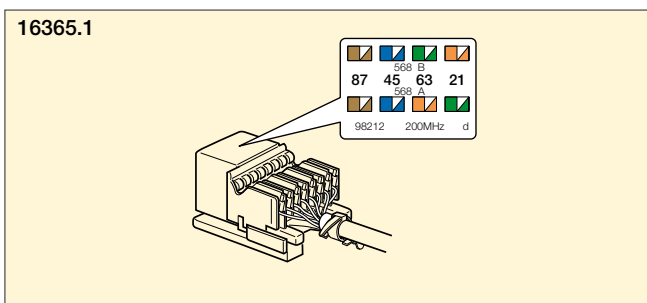
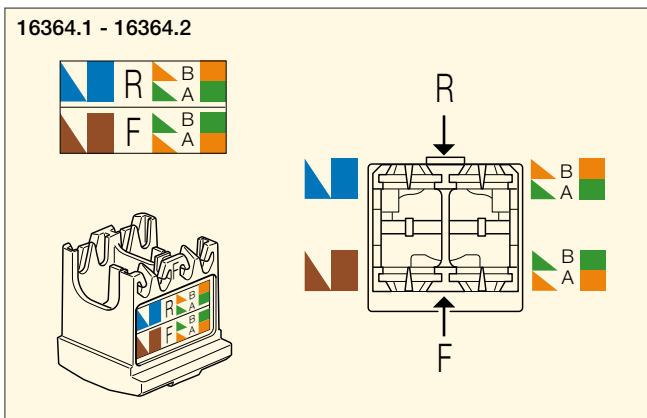
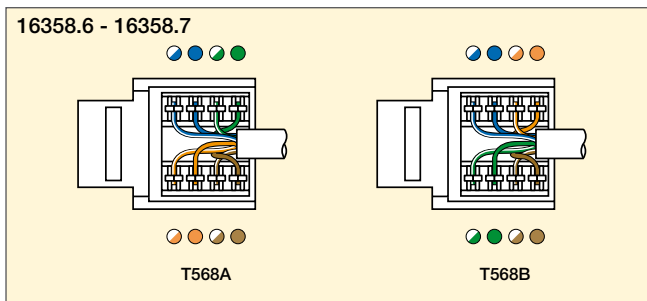
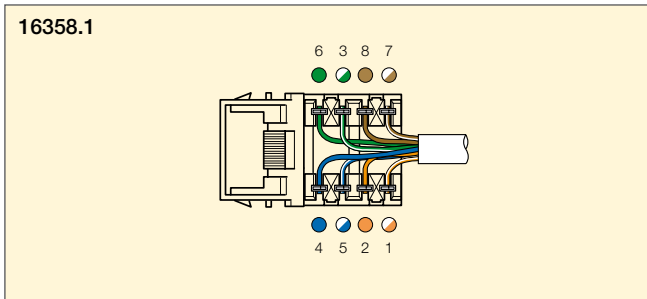

## Signal reception socket outlets

### EDP socket connector

<b>16358.1</b>	<b>.B</b>	RJ45 outlet with AT&T/Lucent Technologies/Avaya (MPS100E) connector, Cat. 5e, unshielded, T568A/B universal wiring, 8 contacts, insulation-piercing terminals
<b>16358.6</b>	<b>.B</b>	RJ45 outlet, with AMP/Tyco connector, Cat. 5e, unshielded, T568A/B universal wiring, 8 contacts, insulation-piercing terminals
<b>16358.7</b>	<b>.B</b>	RJ45 outlet, with AMP/Tyco connector, Cat. 5e, shielded, T568A/B universal wiring, 8 contacts, insulation-piercing terminals



**16358.1**  
grey



**16358.1.B**  
white

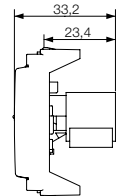

**16358.6**  
grey



**16358.6.B**  
white

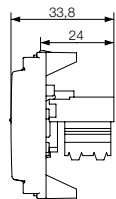

**16358.7**  
grey



**16358.7.B**  
white

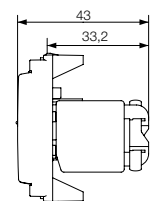

### EDP socket connector

<b>16364.1</b>	<b>.B</b>	RJ45 outlet with Panduit (MINI-COM) connector, Cat. 5e, unshielded, T568A/B universal wiring, 8 contacts, insulation-piercing terminals
<b>16364.2</b>	<b>.B</b>	RJ45 outlet with Panduit (MINI-COM) connector, Cat. 5e, shielded, T568A/B universal wiring, 8 contacts, insulation-piercing terminals
<b>16365.1</b>	<b>.B</b>	RJ45 outlet with R&M Freenet system connector, Cat. 5e, unshielded, T568A/B universal wiring, 8 contacts, insulation-piercing terminals



**16364.1**  
grey



**16364.1.B**  
white

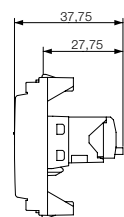

**16364.2**  
grey



**16364.2.B**  
white

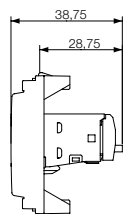

**16365.1**  
grey



**16365.1.B**  
white

