

## Switches - TECHNICAL CHARACTERISTICS

### Lightable name-plate push button

To be supplied through safety isolating transformer.

### Microtube lamps

#### Technical specifications of microtube lamps

| Article | Type         | Voltage | W   | Dimensions | Colour |
|---------|--------------|---------|-----|------------|--------|
| 07054.L | incandescent | 12 V    | 3 W | ø 7x37     | white  |
| 07055.L | incandescent | 24 V    | 3 W | ø 7x37     | white  |

16190 - Wiring diagram

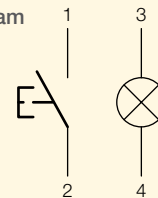

Name-plate opening

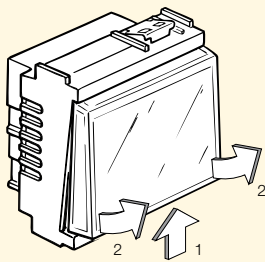

Microtube lamp and customized cardboard assembly

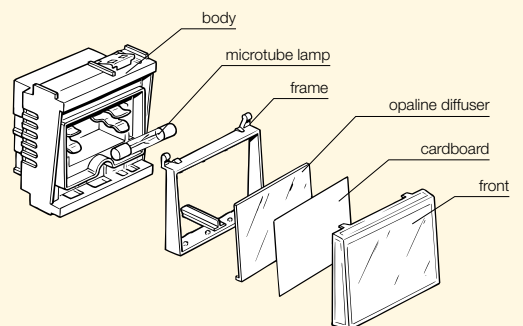

# Switches

## Special 1P push button

|              |           |   |
|--------------|-----------|---|
| <b>16190</b> | <b>.B</b> | 1P NO 10 A 12-24 V~ (SELV) push button, with lightable name-plate, for 12-24 V 3 W $\varnothing$ 7x37 mm microtube lamp - 2 modules.<br>Provided without lamp |
|--------------|-----------|---|



**16190**  
grey



**16190.B**  
white

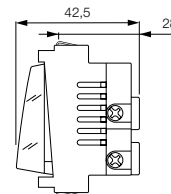

## Special 1P push button

|              |           |  |
|--------------|-----------|--|
| <b>16083</b> | <b>.B</b> | 1P NC 10 A 250 V~ cord-operated push button, with 1,5 m cord |
| <b>16084</b> | <b>.B</b> | 1P NO 10 A 250 V~ cord-operated push button, with 1,5 m cord |



**16083**  
**16084**  
grey



**16083.B**  
**16084.B**  
white

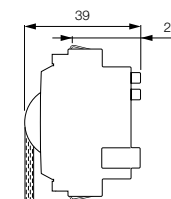

## Additional 1P push button 250 V~

|              |           |  |
|--------------|-----------|--|
| <b>16101</b> | <b>.B</b> | 1P NO (ON) 16 A push button                                  |
| <b>16104</b> | <b>.B</b> | 1P NC (OFF) 16 A push button                                 |
| <b>16107</b> | <b>.B</b> | 1P NO (ON) 16 A push button, with NC 16 A auxiliary contact  |
| <b>16110</b> | <b>.B</b> | 1P NC (OFF) 16 A push button, with NO 16 A auxiliary contact |

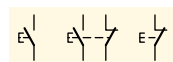

**16101**  
grey



**16101.B**  
white



**16104**  
grey



**16104.B**  
white

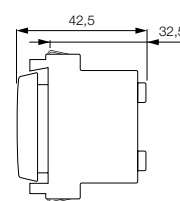

**16107**  
grey



**16107.B**  
white



**16110**  
grey



**16110.B**  
white

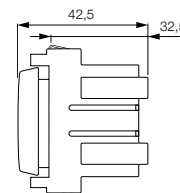

# Switches

## 1P reversing switch 250 V~

**17005** .B 1P 16 AX reversing switch



Technical specifications, pages 120-122



**17005**  
grey



**17005.B**  
white

## 1P NO push button 250 V~

**17010** .B 1P NO 10 A 250 V~ push button, general symbol

**17010.G** .B 1P NO 10 A 250 V~ push button, general symbol - 2 reduced modules

**Δ 17010.F** .B 1P NO 10 A 250 V~ push button, general symbol, with luminescent indicator



Technical specifications, page 124



**17010**  
grey



**17010.B**  
white



**17010.G**  
grey



**17010.G.B**  
white



**17010.F**  
grey



**17010.F.B**  
white

## 1P NO push button

**17010.L** .B 1P NO 10 A 250 V~ push button, luminous, for signalling unit. Supplied without signalling unit

**17020** .B 1P NO 10 A 250 V~ push button 12-24 V~ (SELV), with lightable name plate for 12-24 V 3 W ø 7x37 mm microtube lamp - 2 reduced modules. Supplied without lamp



Technical specifications, pages 124-128



**17010.L**  
grey



**17010.L.B**  
white



**17020**  
grey



**17020.B**  
white