

Switches - TECHNICAL CHARACTERISTICS

Lightable name-plate push button

To be supplied through safety isolating transformer.

Microtube lamps

Technical specifications of microtube lamps

Article	Type	Voltage	W	Dimensions	Colour
07054.L	incandescent	12 V	3 W	ø 7x37	white
07055.L	incandescent	24 V	3 W	ø 7x37	white

16190 - Wiring diagram

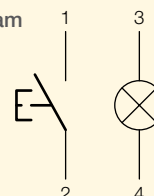

Name-plate opening

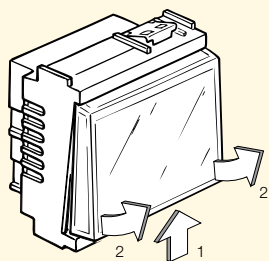

Microtube lamp and customized cardboard assembly

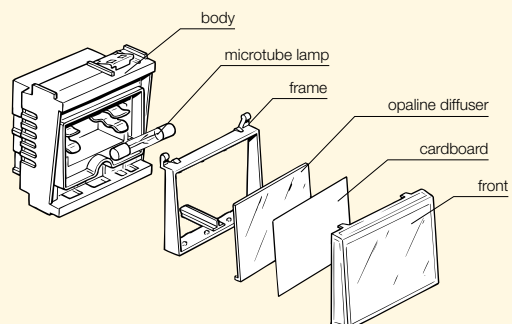

Switches

Special 1P push button

16190	.B	1P NO 10 A 12-24 V~ (SELV) push button, with lightable name-plate, for 12-24 V 3 W \varnothing 7x37 mm microtube lamp - 2 modules. Provided without lamp
--------------	-----------	---



16190
grey



16190.B
white

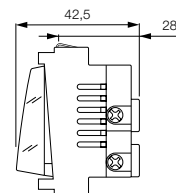

Special 1P push button

16083	.B	1P NC 10 A 250 V~ cord-operated push button, with 1,5 m cord
16084	.B	1P NO 10 A 250 V~ cord-operated push button, with 1,5 m cord



16083
16084
grey



16083.B
16084.B
white

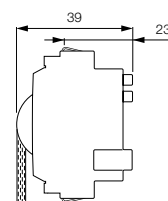

Additional 1P push button 250 V~

16101	.B	1P NO (ON) 16 A push button
16104	.B	1P NC (OFF) 16 A push button
16107	.B	1P NO (ON) 16 A push button, with NC 16 A auxiliary contact
16110	.B	1P NC (OFF) 16 A push button, with NO 16 A auxiliary contact

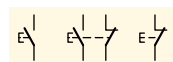

16101
grey



16101.B
white



16104
grey



16104.B
white

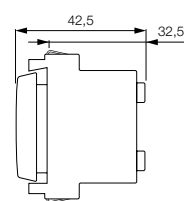

16107
grey



16107.B
white



16110
grey



16110.B
white

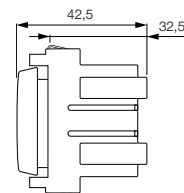

Switches

1P NO push button 250 V~

10236	1P NO 10 A push button, bell symbol
Δ 10240	As above, maid symbol
Δ 10241	As above, waiter symbol
Δ 10242	As above, valet symbol
Δ 10263	As above, key symbol
10264	As above, light symbol

Technical specifications: see page 124



Special 1P NO push button

10725	1P NO 10 A 12-24 V (SELV) lightable name-plate push button for 12 or 24 V 3 W \varnothing 7x31 mm lamp - provided with resin self-bearing cover plate, ivory, for round mounting boxes and screw covering strips 10798.01
10773	1P NO 10 A 12-24 V (SELV) lightable name-plate push button for 12 or 24 V 3 W \varnothing 7x31 mm lamp - provided with resin self-bearing cover plate, ivory, for 3-module mounting boxes and screw covering strips 10797.01

Technical specifications: see page 128



Additional 1P push button 250 V~

Δ 10271	1P NO 10 A push button (ON)
Δ 10272	1P NC 10 A push button (OFF)

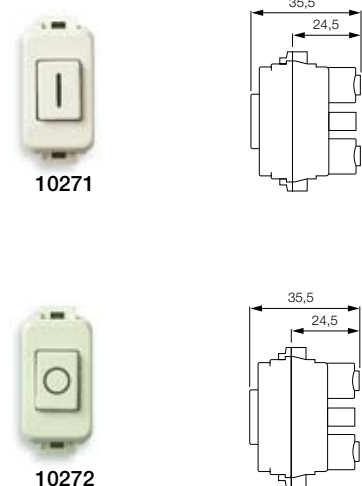

Side views show the overall dimensions and the flush depth in mm
Mounting boxes and cover plates, page 380

* Only for Countries not members of the EU
Δ Available until stock lasts