

Surface mounting boxes - TECHNICAL CHARACTERISTICS

Technical specifications

- surface mounting boxes for: Eikon, Idea, Plana, 8000, from 1 to 3 modules
- available with 12 or 18 modules for Idea, three colour range
- available with 14 or 21 modules for Eikon and Plana, three colour range
- 2 types with 30 mm of depth, three colour range
- 2 types of surface mounting covers for 8000
- solidity and stiffness granted in any point by the materials used and their thickness
- wide inner space
- resistance to ageing, according to EN 60670-1: 7 days at 70 °C
- resistance to heat with ball-pressure test, according to EN 60670-1: 70 °C
- the 09951.A, 09952.A, 09972..., 09973..., 09974..., 09975... 09976... surface mounting boxes have to be installed on insulating non-perforated or metallic with earth connection surfaces.

Conformity to Standards

LV Directive
EN 60670-1 Standard

7+7-module Plana surface mounting box



30 mm deep surface mounting box

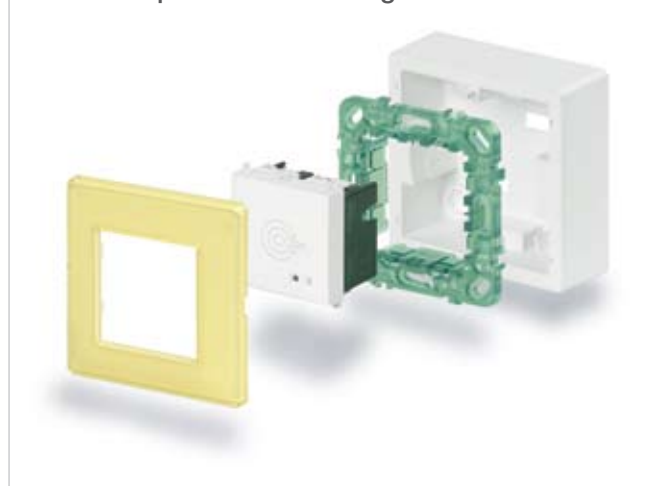

Dimensions (in mm)

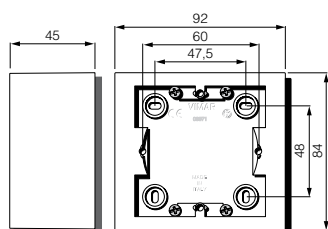

09971...

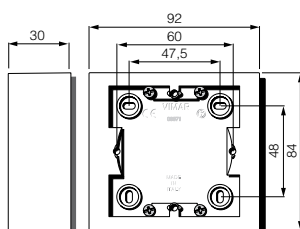

09972...

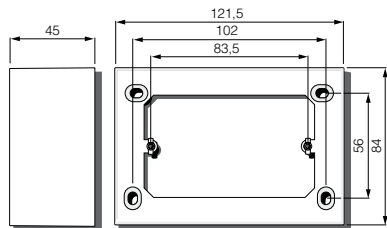

09975...

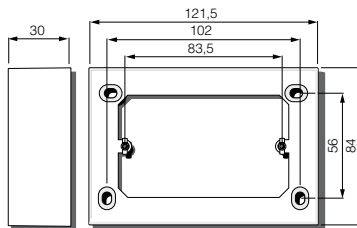

09976...

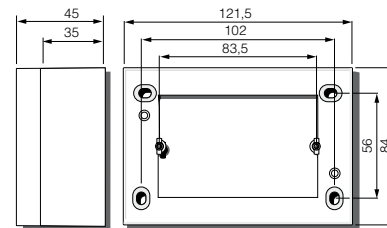

09983...

Surface mounting boxes

Surface mounting box

| | | | |
|-----------------|------------|------------|---|
| 09971.A | .01 | .SL | Square surface mounting box, 43,5 mm depth, for 1- or 2-reduced-module Idea and 2-module Eikon and Plana with relevants mounting frames and cover plates. Idea series: suitable for Classica cover plate only |
| 09972.01 | .SL | | Square surface mounting box, 30 mm depth, for 1- or 2-reduced-module Idea and 2 module Eikon and Plana with relevants mounting frames and cover plates, white. To be installed on insulating non-perforated or metallic with earth connection surfaces. |



09971.A
ivory



09971.01
white



09971.SL
Silver



09972.01
white



09972.SL
Silver

Surface mounting box

| | | | |
|-----------------|------------|------------|--|
| 09975.A | .01 | .SL | 3-module surface mounting box, 43,5 mm depth, for Eikon, Idea and Plana with relevants mounting frame and cover plates. To be installed on insulating non-perforated or metallic with earth connection surfaces. Idea: suitable only for Classica cover plates |
| 09976.04 | .14 | | 3-module surface mounting box, 30 mm depth, for Eikon, Idea and Plana with relevants mounting frame and cover plates. To be installed on insulating non-perforated or metallic with earth connection surfaces. Idea: suitable only for Classica cover plates |



09975.A
ivory



09975.01
white



09975.SL
Silver



09976.04
Idea white



09976.14
Idea grey

Surface mounting box

| | | | |
|--------------|------------|-----------|---|
| 09983 | .01 | .N | 3-module surface mounting box, 35/45 mm depth, for Eikon, Idea and Plana with relevants mounting frame and cover plates |
|--------------|------------|-----------|---|



09983
grey



09983.01
white



09983.N
Next

Surface mounting boxes - TECHNICAL CHARACTERISTICS

Dimensions (in mm)

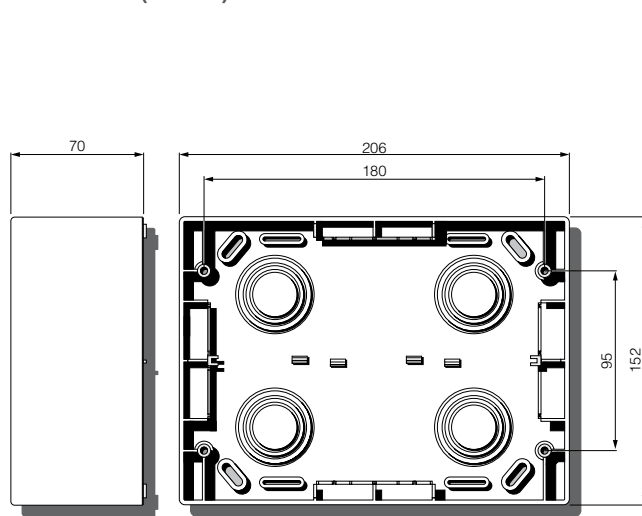

09920...

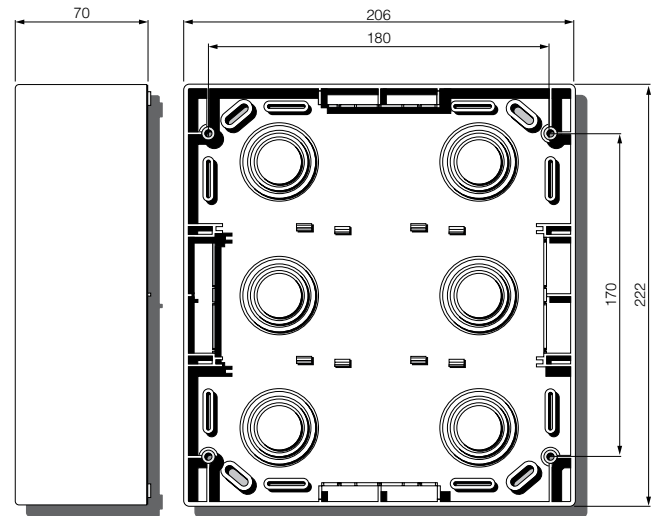

09921...

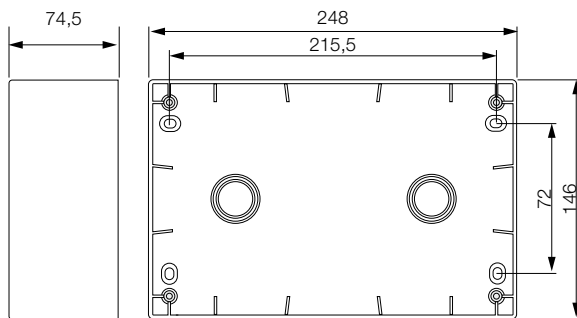

16894 ...

Surface mounting boxes

Surface mounting box

| | |
|-----------------|--|
| 09920.01 | Mounting box for 12-(6+6)-module Idea and 14-(7+7)-module Eikon and Plana surface mounting with relevant mounting frames and cover plates, white |
| 09920.04 | As above, Idea white |
| 09920.14 | As above, Idea grey |
| 09920.N | As above, Next |
| 09920.SL | As above, Silver |
| 09921.01 | Mounting box for 18-(6+6+6)-module Idea and 21-(7+7+7)-module Eikon and Plana surface mounting with relevant mounting frames and cover plates, white |
| 09921.04 | As above, Idea white |
| 09921.14 | As above, Idea grey |
| 09921.N | As above, Next |
| 09921.SL | As above, Silver |



09920...



09921...

Surface mounting box for back-up unit

| | |
|-----------------|---|
| 16894 | Surface mountign box for back-up unit, grey |
| 16894.B | As above, Idea white |
| 16894.N | As above, Next |
| 16894.01 | As above, white |
| 16894.SL | As above, Silver |



16894
grey



16894.N
Next



16894.SL
Silver



16894.B
Idea white



16894.01
white

Surface mounting boxes - TECHNICAL CHARACTERISTICS

Dimensions (in mm)

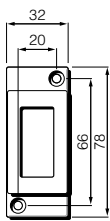

09951.A
09952.A

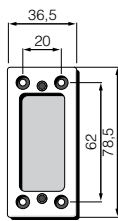

09956...
09957...

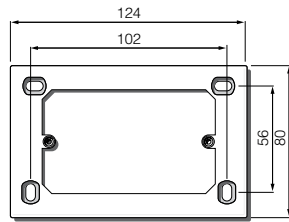

09973...
09974...
09968

Surface mounting boxes

Surface mounting cover for 8000

09951.A Monobloc cover, 45 mm depth, for 1 8000 standard module surface mounting, RAL 9001 ivory. To be installed on insulating non-perforated or metallic with earth connection surfaces. Not suitable for 08064..., 08065..., 08388..., 08389..., 08390...

09952.A Monobloc cover, 50 mm depth, for 1 8000 standard module surface mounting, RAL 9001 ivory. To be installed on insulating non-perforated or metallic with earth connection surfaces.

Not suitable for

08065..., 08388..., 08389..., 08390...



09951.A



09952.A

Surface mounting box for 8000

09956 Mounting box with backplate, 40 mm depth, for 1 8000 standard module surface panel mounting with relevant mounting frames and cover plates, ivory. Not suitable for 08064..., 08065..., 08388..., 08389..., 08390...

09956.A As above, RAL 9001 ivory

Δ 09957 Mounting box with backplate, 48 mm depth, for 1 8000 standard module surface panel mounting with relevant mounting frames and cover plates, ivory. Not suitable for 08065..., 08388..., 08389..., 08390...

Δ 09957.A As above, RAL 9001 ivory



09956
09956.A



09957
09957.A

Surface mounting box for 8000, Linea

09973 3-module mounting box, 40 mm depth, for 8000 and Linea switch surface mounting with relevant mounting frame, cover plates or self-bearing cover plates, ivory. To be installed on insulating non-perforated or metallic with earth connection surfaces. Not suitable for 08065..., 08081..., 08341, 08342, 08388..., 08389..., 08390..., 08440, 08441, 08443, 08445, 08446, 08448, 08450, 08470, 08480, 08481, 10064..., 10065..., 10081...

09973.A As above, RAL 9001 ivory

09974 3-module mounting box, 48 mm depth, for 8000 and Linea switch surface mounting with relevant mounting frames, cover plates or self-bearing cover plates, ivory. To be installed on insulating non-perforated or metallic with earth connection surfaces

09974.A As above, RAL 9001 ivory

09968 3-module surface or table mounting box, 40 mm depth, for 8000 and Linea switch surface mounting with relevant mounting frame, cover plates or self-bearing cover plates, ivory. To be installed on insulating non-perforated or metallic with earth connection surfaces.

Not suitable for 08065..., 08081..., 08341, 08342, 08388..., 08389..., 08390..., 08440, 08441, 08443, 08445, 08446, 08448, 08450, 08470, 08480, 08481, 10064..., 10065..., 10081...



09973
09973.A



09974
09974.A



09968