

Switches - TECHNICAL CHARACTERISTICS

Lightable name-plate push button

To be supplied through safety isolating transformer.

Microtube lamps

Technical specifications of microtube lamps

| Article | Type | Voltage | W | Dimensions | Colour |
|---------|--------------|---------|-----|------------|--------|
| 07054.L | incandescent | 12 V | 3 W | ø 7x37 | white |
| 07055.L | incandescent | 24 V | 3 W | ø 7x37 | white |

16190 - Wiring diagram

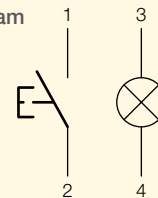

Name-plate opening

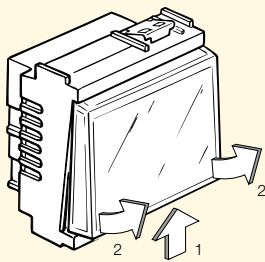

Microtube lamp and customized cardboard assembly

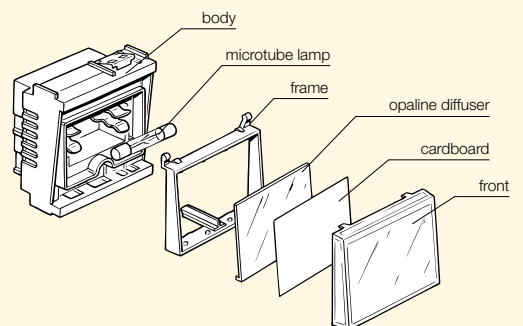

Special 1P push button

| | | |
|--------------|-----------|---|
| 16190 | .B | 1P NO 10 A 12-24 V~ (SELV) push button, with lightable name-plate, for 12-24 V 3 W \varnothing 7x37 mm microtube lamp - 2 modules. Provided without lamp |
|--------------|-----------|---|



16190
grey



16190.B
white

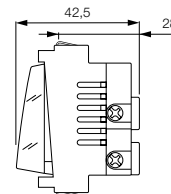

Special 1P push button

| | | |
|--------------|-----------|--|
| 16083 | .B | 1P NC 10 A 250 V~ cord-operated push button, with 1,5 m cord |
| 16084 | .B | 1P NO 10 A 250 V~ cord-operated push button, with 1,5 m cord |



16083
16084
grey



16083.B
16084.B
white

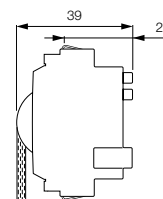

Additional 1P push button 250 V~

| | | |
|--------------|-----------|--|
| 16101 | .B | 1P NO (ON) 16 A push button |
| 16104 | .B | 1P NC (OFF) 16 A push button |
| 16107 | .B | 1P NO (ON) 16 A push button, with NC 16 A auxiliary contact |
| 16110 | .B | 1P NC (OFF) 16 A push button, with NO 16 A auxiliary contact |

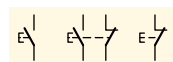

16101
grey



16101.B
white



16104
grey



16104.B
white

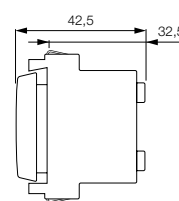

16107
grey



16107.B
white



16110
grey



16110.B
white

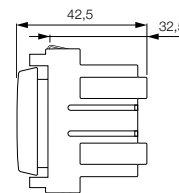

1P NO push button 250 V~

| | |
|--------------|--------------------------------------|
| 08236 | 1P NO 10 A push button, bell symbol |
| 08263 | 1P NO 10 A push button, key symbol |
| 08264 | 1P NO 10 A push button, light symbol |

Technical specifications: see page 124

**Special 1P NO push button**

| | |
|--------------|---|
| 08270 | 1P NO 10 A 250 V~ cord-operated push button, with 1,5 m cord |
| 08420 | 1P NO 10 A 12-24 V (SELV) push button with lightable name plate for 12 or 24 V 3 W \varnothing 7x31 mm lamp - 2 special modules. Supplied without lamp |

Technical specifications: see page 128

**1P push button - supplied with mounting frame and cover plate for round mounting boxes**

| | |
|-------------------|--|
| 08625 | 1P NO 10 A 12-24 V (SELV) lightable name-plate push button for 12 or 24 V 3 W \varnothing 7x31 mm lamp - provided with mounting frame and anodized aluminium cover plate for round mounting boxes, snap fixing, gold. Provided without lamp |
| 08625.BR | As above, anodized aluminium, bronze |
| 08625.N | As above, anodized aluminium, black |
| 08625.A | As above, resin, ivory |
| 08625.Z | As above, resin, white |
| Δ 08525 | 1P NO 10 A 12-24 V (SELV) lightable name-plate push button for 12 or 24 V 3 W \varnothing 7x31 mm lamp - provided with mounting frame and anodized aluminium cover plate for round mounting boxes, screw fixing, gold. Provided without lamp |
| Δ 08525.BR | As above, anodized aluminium, bronze |
| Δ 08525.N | As above, anodized aluminium, black |

Technical specifications: see page 128



08625...
08525...