



# Standard Deckhatches - WITHOUT FLANGE



**Styling,  
safety  
and  
comfort.**

**100% DUTCH MADE**

For over 25 years the Gebo standard deckhatch is the most widely used hatch in the world. This Dutch hatch is made from finest quality, seawater resistant, anodised aluminium and has a standard smoke grey acrylic panel of 10 or 15 mm thickness. All other parts, including hinges

and handles, are also constructed from non-corrosive materials.

**STANDARD DECKHATCH DESIGN**

The standard hatch is provided without a flange for easy installation on the deck. A deep groove in the lower frame keeps water from

coming in when the hatch is open.

**COLOUR OF THE ACRYLIC**

The standard hatch is manufactured with grey smoke acrylic. Clear, bronze and green acrylic are available to special order.

**CATEGORY:**  
**A + B + C + D**  
**AREA II**  
*See page 37*

## Accessories



Standard hatch

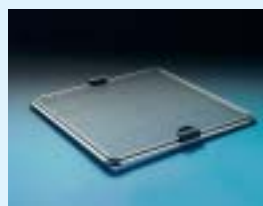

Mosquito screen



Fly-Blind

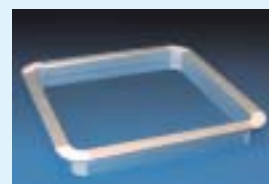

Aluminium Innerrim





■ Unique deep-deck groove helps keep water out



■ Stepless opening through 180° and beyond



■ No-catch design for greater safety



Standard deckhatch without flange

Standard deckhatch without flange - sizes

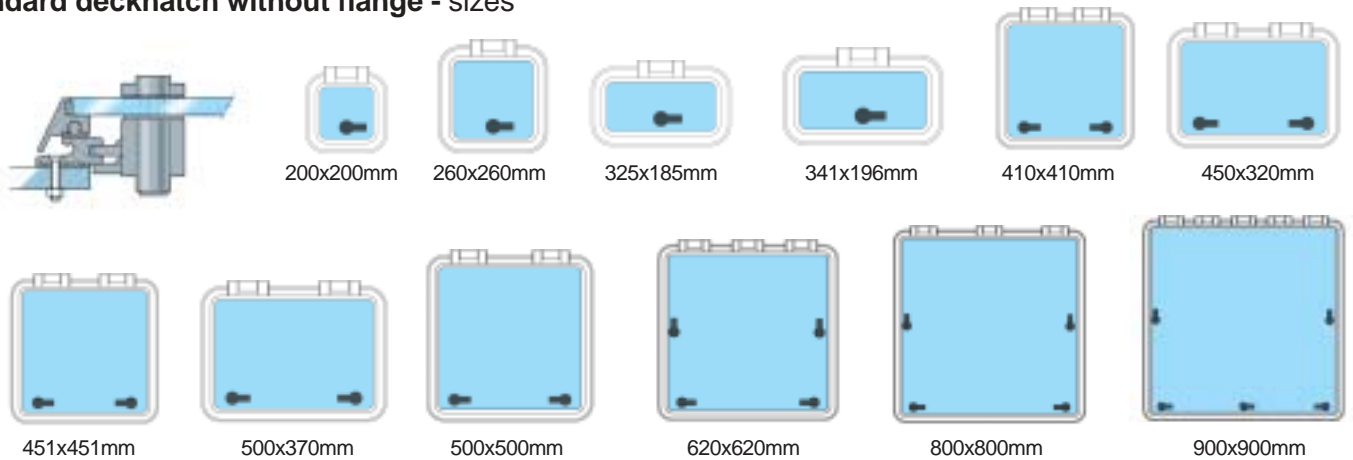

Hatches should be fitted to a flat surface with a maximum tolerance of 1mm.

STANDARD HATCHES WITHOUT FLANGE - SPECIFICATIONS

Art.No.	Cut-Out size L x B	Radius	Overall size L x B	Radius	Acrylic	Mosquito screen	Mosquito screen sizes	Aluminium Innerrim	Fly-Blind
80.20.10.00	200x200mm	30	260x260mm	60	10 mm	84.55.01.20	195x195mm	84.00.03.OZ	
80.20.27.00	260x260mm	30	320x320mm	60	10 mm	84.55.01.22	255x255mm	84.01.63.OZ	
80.20.20.00	325x185mm	30	385x245mm	60	10 mm	84.55.01.21	320x180mm	84.00.13.OZ	
80.20.90.00	341x196mm	30	401x256mm	60	10 mm	84.55.01.28	336x191mm	84.00.73.OZ	
80.21.00.00	410x410mm	30	470x470mm	60	10 mm	84.55.01.29	405x405mm	84.00.83.OZ	
80.20.30.00	450x320mm	30	510x380mm	60	10 mm	84.55.01.23	445x315mm	84.00.23.OZ	84.70.01.50
80.20.80.00	451x451mm	30	511x511mm	60	10 mm	84.55.01.30	446x446mm	84.01.73.OZ	
80.20.40.00	500x370mm	30	560x430mm	60	10 mm	84.55.01.24	495x365mm	84.00.33.OZ	84.70.01.51
80.20.50.00	500x500mm	30	560x560mm	60	10 mm	84.55.01.25	495x495mm	84.00.43.OZ	84.70.01.52
80.20.50.01/black	500x500mm	30	560x560mm	60	10 mm	84.55.01.25	495x495mm	84.00.43.OZ	84.70.01.52
80.20.55.00/white	500x500mm	30	560x560mm	60	10 mm	84.55.01.25	495x495mm	84.00.43.OZ	84.70.01.52
80.20.60.00	620x620mm	30	680x680mm	60	15 mm	84.55.01.26	615x615mm	84.00.53.OZ	84.70.01.53
80.20.70.00*	800x800mm	30	860x860mm	60	15 mm	84.55.01.31		84.00.63.OZ	
80.20.75.00*	900x900mm	30	960x960mm	60	15 mm				

\* = with gasspring





# Standard Deckhatches - WITH FLANGE



**Functionality and safety.**

The standard deckhatch is made from finest quality, seawater resistant, anodised aluminium and has a standard smoke grey acrylic panel of 10 or 15 mm thickness. All other parts, including hinges and handles, are also constructed from non-corrosive materials.

### STANDARD DECKHATCH DESIGN - WITH FLANGE

For a smoother profile, the frame on our standard hatches has been extended to fit flush against the base mounting. The frame covers the base mounting screws for a smoother appearance and extra safety. A deep groove in the lower frame keeps

water from coming in when the hatch is open.

### COLOUR OF THE ACRYLIC

As standard the hatch is being manufactured with grey smoke acrylic. Clear, bronze and green acrylic are available on special order.

*Hatches with a flange and corner radius 30 can be manufactured to order.*

**CATEGORY:**  
**A + B + C + D**  
**AREA II**  
 See page 37

## Accessories



Standard hatch

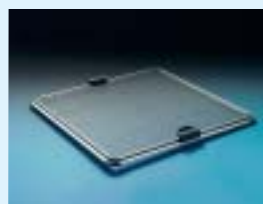

Mosquito screen



Fly-Blind

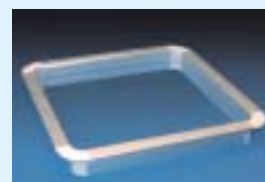

Aluminium Innerrim





■ Unique deep-deck groove helps keep water out



■ Stepless opening through 180° and beyond



■ No-catch design for greater safety

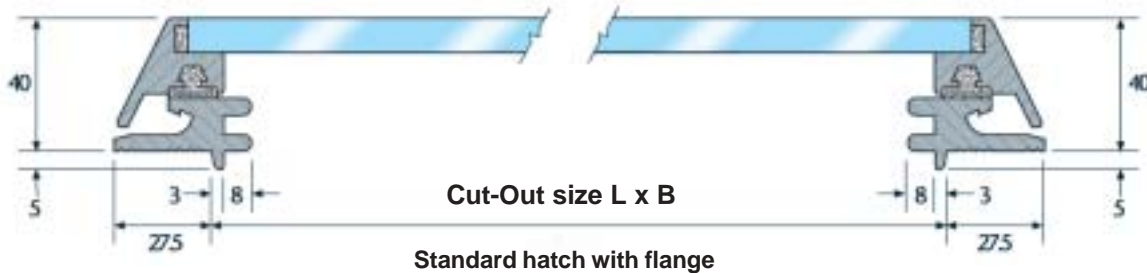

**Standard hatch with flange - sizes**

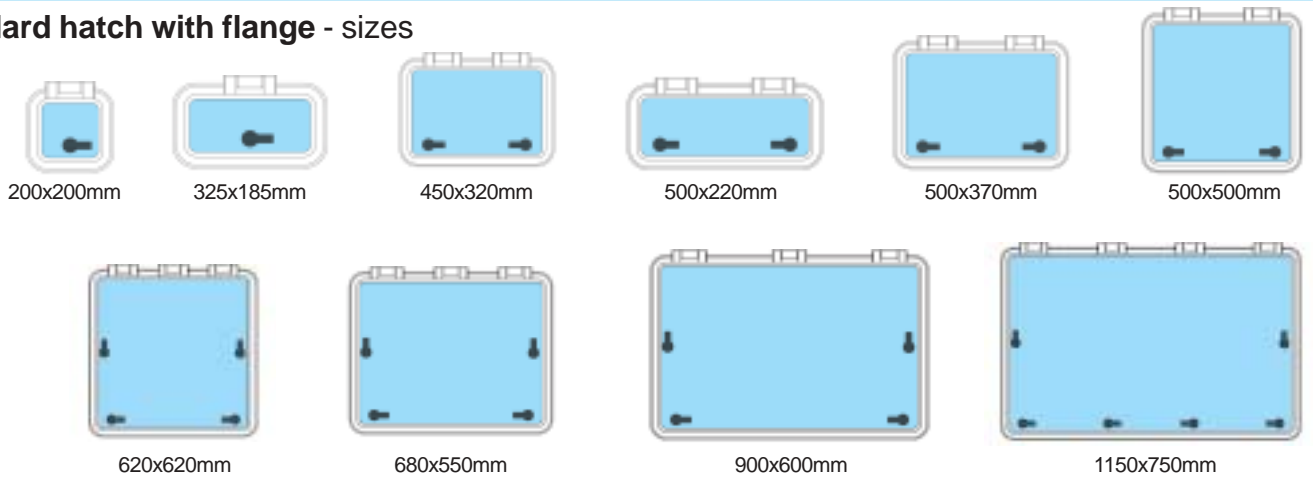

Hatches should be fitted to a flat surface with a maximum tolerance of 1mm.

**STANDARD HATCHES WITH FLANGE - SPECIFICATIONS**

Art.No.	Cut-Out size L x B	Radius	Overall size L x B	Radius	Acrylic	Mosquito screen	Mosquito screen size	Aluminium Innerrim	Fly-Blind
80.29.00.00	200x200mm	30	255x255mm	58	10mm			84.00.03.0M	
80.29.10.00	325x185mm	30	380x240mm	58	10mm	84.55.01.50	315x175mm	84.00.13.0M	
80.29.20.00	450x320mm	30	505x375mm	58	10mm	84.55.01.54	440x310mm	84.01.23.0M	84.70.01.50
80.21.10.00	450x320mm	55	505x375mm	83	10mm	84.55.00.40	436,5x310mm	84.00.25.5M	84.70.01.50
80.29.80.00	500x220mm	30	555x275mm	58	10mm	84.55.00.55	490x210mm	84.01.33.0M	84.70.01.51
80.29.30.00	500x370mm	30	555x425mm	58	10mm	84.55.01.51	490x360mm	84.00.33.0M	84.70.01.51
80.21.20.00	500x370mm	55	555x425mm	83	10mm	84.55.00.41	486,5x360mm	84.00.35.5M	84.70.01.51
80.29.40.00	500x500mm	30	555x555mm	58	10mm	84.55.01.52	490x490mm	84.00.43.0M	84.70.01.52
80.21.30.00	500x500mm	55	555x555mm	83	10mm	84.55.00.42	490x490mm	84.00.45.5M	84.70.01.52
80.21.30.10 white	500x500mm	55	555x555mm	83	10mm	84.55.00.42	486,5x540mm	84.00.45.5M	84.70.01.52
80.21.30.01 black	500x500mm	55	555x555mm	83	10mm	84.55.00.42	486,5x490mm	84.00.45.5M	84.70.01.52
80.29.60.00	620x620mm	30	675x675mm	58	10mm	84.55.01.53	610x610mm	84.00.53.0M	84.70.01.53
80.21.40.00	620x620mm	55	675x675mm	83	15mm	84.55.00.43	606,5x610mm	84.00.55.5M	84.70.01.53
80.21.45.00	680x550mm	55	735x615mm	83	15mm	84.55.00.45	666,5x540mm		84.70.01.53
80.30.10.00	900x600mm	55	955x655mm	83	15mm	84.55.00.44			
80.23.00.00	1150x750mm	55	1205x805mm	83	15mm	84.55.00.49			





# FlushLine Deckhatches



**Sleek profile  
for today's  
power craft**

Gebo's new 'FlushLine' deckhatches offer exciting options for power craft - and like our FlushLine portlights, their sleek, low-profile looks work perfectly with the smooth, flowing lines of today's boat designs.

acrylic. Clear, bronze and green acrylic are available to special order.

Adjustable friction hinges hold the hatch open in any position up to 180°, including a fully-locked ventilation position. For maximum security the handles incorporate a sturdy, easy-to-use blue locking button.

**BENEFITS THAT USERS  
WILL APPRECIATE DAY  
AFTER DAY; YEAR AFTER  
YEAR**

**COLOUR OF THE ACRYLIC**

As standard the hatch is being manufactured with grey smoke

End users will appreciate Gebo design and quality too. There are no sharp edges to snag clothes or lines.



*For added convenience, optional stays are available for all but the smallest-size FlushLine hatch.*

**CATEGORY:  
A+B+C+D**  
  
See page 37

## Accessories



FlushLine hatch



Mosquito screen

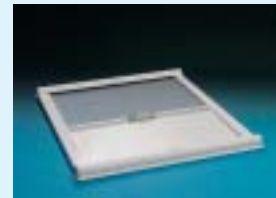

Fly-blind



ABS Innerrim

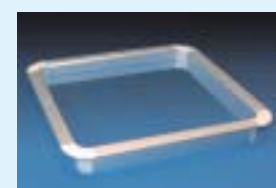

Aluminium innerrim





■ Extra-low profile: only 24 mm above deck



■ Friction hinges for easy, stepless opening up to 180°



■ No sharp corners to catch lines or clothing

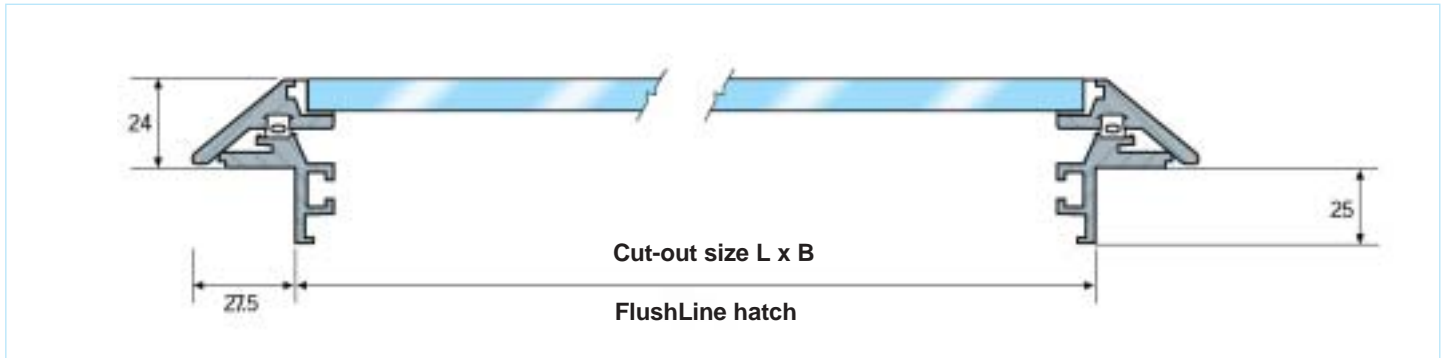

**FlushLine hatches - sizes**

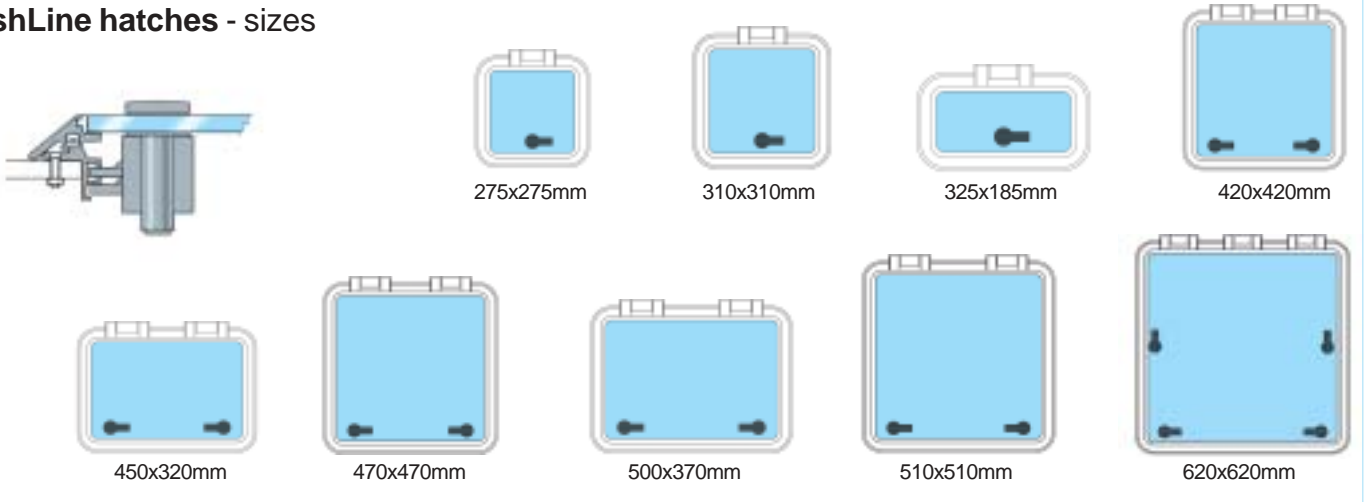

Hatches should be fitted to a flat surface with a maximum tolerance of 1mm.

**FLUSHLINE HATCHES - SPECIFICATIONS**

Art.nr.	Cut-out size L x B	Radius	Overall size L x B	Radius	Acrylic	Mosquito screen	Mosquito screen size	Aluminium Innerrim	ABS Innerrim	Fly-Blind
80.50.30.00	275x275mm	42	330x330mm	70	8mm	84.50.00.00		84.00.94.2M	84.60.00.00	
80.50.31.00	310x310mm	42	365x365mm	70	8mm					
80.50.35.00	325x185mm	42	380x240mm	70	8mm	84.50.00.12	324x184mm	84.00.14.2M		
80.50.60.00	420x420mm	42	475x475mm	70	8mm	84.50.00.01	419x419mm	84.01.04.2M	84.60.00.01	
80.55.60.00	420x420mm	42	475x475mm	70	10mm	84.50.00.01	419x419mm	84.01.04.2M	84.60.00.01	
80.50.60.50*	420x420mm	42	475x475mm	70	8mm	84.50.00.01	419x419mm	84.01.04.2M	84.60.00.01	
80.50.40.01	450x320mm	42	505x375mm	70	8mm	84.50.00.09	449x319mm	84.00.24.2M		84.70.01.50
80.55.40.01	450x320mm	42	505x375mm	70	10mm	84.50.00.09	449x319mm	84.00.24.2M		84.70.01.50
80.50.80.00	470x470mm	42	525x525mm	70	8mm	84.50.00.02	469x469mm	84.01.14.2M	84.60.00.02	
80.50.80.50*	470x470mm	42	525x525mm	70	8mm	84.50.00.02	469x469mm	84.01.14.2M	84.60.00.02	
80.50.70.50	500x370mm	42	555x425mm	70	8mm	84.50.00.04	499x369mm	84.00.34.2M	84.60.00.06	84.70.01.51
80.50.70.60*	°500x370mm	42	555x425mm	70	8mm	84.50.00.04	499x369mm	84.00.34.0M	84.60.00.06	84.70.01.51
80.55.90.00	510x510mm	42	565x565mm	70	10mm	84.50.00.03	509x509mm	84.01.24.2M	84.60.00.03	84.70.01.52
80.55.90.50*	510x510mm	42	565x565mm	70	10mm	84.50.00.03	509x509mm	84.01.24.2M	84.60.00.03	84.70.01.52
80.55.10.00	620x620mm	42	675x675mm	70	10mm	84.50.00.05	619x619mm	84.00.54.2M	84.60.00.05	84.70.01.53
80.56.00.50*	620x620mm	42	675x675mm	70	10mm	84.50.00.05	619x619mm	84.00.54.2M	84.60.00.05	84.70.01.53

\*=with stay (stay: Art.nr 84.50.00.00)

°= green acrylic





# FlushLine Deckhatches

## Round & Delta

The FlushLine deck-hatches are made from finest quality seawater resistant anodised aluminium and have a standard smoke grey acrylic panel of 10 or 15mm thickness. All other parts including hinges and handles, are also constructed from

non-corrosive materials. As standard the hatch is being manufactured with grey smoke acrylic. Clear, bronze and green acrylic are available to special order.

**CATEGORY:**

**A + B + C + D**

*See page 37*



FlushLine Hatch Delta



FlushLine Hatch Round

**INTEGRATED STEPLESS HINGE**

The stepless hinges create the opportunity to open the hatch in any position you like up to 180°. The hatch also has a lockable ventilation position that offers security while providing fresh air to the vessel! The extra sturdy, adjustable hinge will provide years of maintenance-free use.



**ACCESSORIES:**

**COLOUR OF THE ACRYLIC**

As standard the hatch is being manufactured with grey smoke acrylic. Clear, bronze and green acrylic are available to special order.



ABS Innerrim



ABS Innerrim





■ Extra-low profile: only 24 mm above deck



■ Friction hinges for easy, stepless opening up to 180°



■ No sharp corners to catch lines or clothing

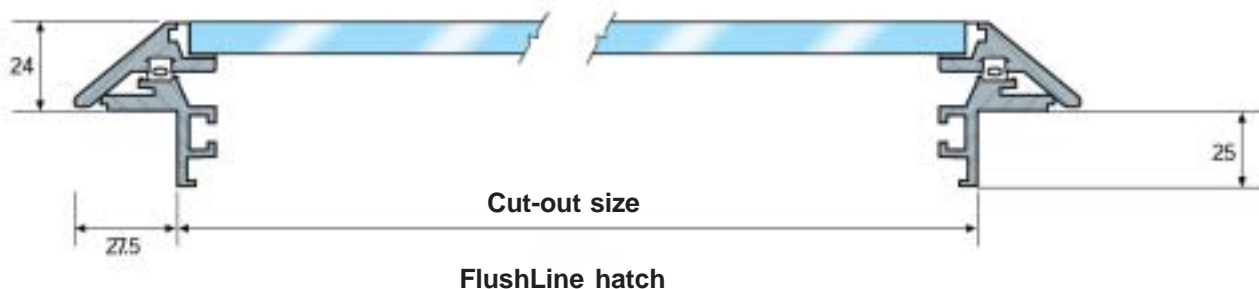

**FlushLine hatches - sizes**



**Round hatch**

**Delta hatch**



277mm



420mm



518mm



530x435mm

Hatches should be fitted to a flat surface with a maximum tolerance of 1mm.

**FLUSHLINE HATCHES ROUND & DELTA - SPECIFICATIONS**

Art.No.	Cut-out size	Radius	Overall Diameter	Radius	Acrylic	Mosquito screen	ABS Innerrim
<b>ROUND HATCH:</b>							
<b>Anodised:</b>							
80.55.27.70	277mm		282mm		10mm	84.50.00.16	
80.55.42.00	420mm		475mm		10mm	84.50.00.14	84.60.00.08
80.55.51.00	518mm		573mm		10mm	84.50.00.15	84.60.00.09
<b>DELTA HATCH:</b>							
80.50.50.00	530x435mm	42	585x490	70	8mm	84.50.00.18	84.60.00.07



# How to measure sizes

## Portlights:

### Take the following into account:

- Will the portlight open inward or outward?
- Is the portlight shape rectangular or circular ended?
- What is the total outside measurement?
- Portlights should be fitted to a flat surface with a maximum tolerance of 1mm over the length.

The cut out size is the total outside size minus 24mm. Rainshield and flyscreens are available for the portlights. They are listed according to cut out size.

## Hatches:

### Take the following into account:

- Hatches should be fitted to a flat surface with a maximum tolerance of 1mm.
- Take measurements of the cut out size in the deck.
- Will you have wood trim on the inside or not?
- When wood is not required on the inside, you may use a hatch with a flange.
- When you do require a wood trim on the inside or are replacing an existing (Gebo) flatbase hatch, we recommend a hatch without a flange.
- What is the radius of the corners?
- Flushline Hatches with a flange always have a corner radius 42

